

## DualGauge™

Dual-Channel Measurement and  
Control Unit for Compact Gauges

TPG 262

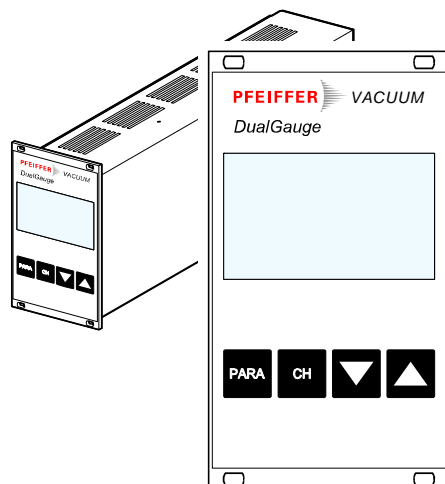

## Product Identification

In all communications with Pfeiffer Vacuum, please specify the information on the product nameplate. For convenient reference copy that information into the space provided below.

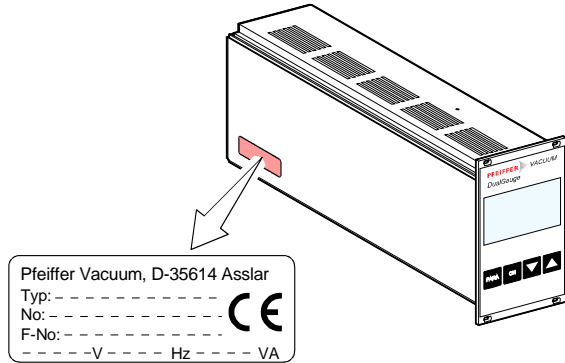

## Validity

This document applies to products with part number PTG28280.

The part number (No.) can be taken from the product nameplate.

This manual is based on firmware version 302-510-A.

If your unit does not work as described in this document, please check that it is equipped with the above firmware version (→ 60).

We reserve the right to make technical changes without prior notice.

All dimensions are indicated in mm.

## Intended Use

The TPG 262 is used together with Pfeiffer Vacuum Compact Gauges (in this document referred to as gauges) for total pressure measurement. All products must be operated in accordance with their respective Operating Instructions.

## Scope of Delivery

The scope of delivery consists of following parts:

- 1 TPG 262 Dual-Channel Measurement and Control Unit
- 1 Power cord
- 1 Connector for *control* connection
- 4 Collar screws and plastic sleeves
- 2 Rubber feet
- 1 Rubber bar
- 1 Operating Instructions (this document)
- 1 Betriebsanleitung



## Trademarks

DualGauge™    INFICON AG  
FullRange™    INFICON GmbH

## Contents

Product Identification	2
Validity	2
Intended Use	3
Scope of Delivery	3
Trademarks	3
<b>1 Safety</b>	<b>6</b>
1.1 Symbols Used	6
1.2 Personnel Qualifications	7
1.3 General Safety Instructions	7
1.4 Liability and Warranty	8
<b>2 Technical Data</b>	<b>9</b>
<b>3 Installation</b>	<b>14</b>
3.1 Personnel	14
3.2 Installation, Setup	14
3.2.1 Rack Installation	14
3.2.2 Installation in a Control Panel	17
3.2.3 Use as Desk-Top Unit	18
3.3 Mains Power Connector	19
3.4 Gauge Connectors <i>sensor 1, sensor 2</i>	20
3.5 <i>control</i> Connector	21
3.6 <i>relay</i> Connector	22
3.7 Interface Connector <i>RS232</i>	23
<b>4 Operation</b>	<b>24</b>
4.1 Front Panel	24
4.2 Turning the TPG 262 On and Off	25
4.3 Operating Modes	26
4.4 Measurement mode	27
4.5 Parameter Mode	31
4.5.1 Switching Function Parameters	33
4.5.2 Gauge Parameters	38
4.5.3 Gauge Control	47
4.5.4 General Parameters	54
4.5.5 Test Parameters	58

<b>5 Communication (Serial Interface)</b>	<b>68</b>
5.1 RS232C Interface	68
5.1.1 Data Transmission	68
5.1.2 Communication Protocol	70
5.2 Mnemonics	72
5.2.1 Measurement Mode	73
5.2.2 Parameter Mode	79
5.2.2.1 Switching Function Parameters	79
5.2.2.2 Gauge Parameters	80
5.2.2.3 Gauge Control	84
5.2.2.4 General Parameters	85
5.2.2.5 Test Parameters	86
5.2.3 Example	92
<b>6 Maintenance</b>	<b>93</b>
<b>7 Troubleshooting</b>	<b>94</b>
<b>8 Repair</b>	<b>95</b>
<b>9 Storage</b>	<b>96</b>
<b>10 Disposal</b>	<b>96</b>
<b>Appendix</b>	<b>97</b>
A: Conversion Tables	97
B: Default Parameter Settings	98
C: Firmware Update	99
D: Literature	102
E: Index	104
<b>Declaration of Conformity</b>	<b>106</b>

For cross-references within this document, the symbol (→  XY) is used, for cross-references to further documents, listed under "Literature", the symbol (→  [Z]).

# 1 Safety

## 1.1 Symbols Used

Symbols for residual risks

 <b>DANGER</b>
<p>Information on preventing any kind of physical injury.</p>

 <b>WARNING</b>
<p>Information on preventing extensive equipment and environmental damage.</p>

 <b>Caution</b>
<p>Information on correct handling or use. Disregard can lead to malfunctions or minor equipment damage.</p>

Further symbols



The lamp/display is lit.



The lamp/display flashes.



The lamp/display is dark.



Press the key (example: PARA key).



Do not press any key.

## 1.2 Personnel Qualifications



### Skilled personnel

All work described in this document may only be carried out by persons who have suitable technical training and the necessary experience or who have been instructed by the end-user of the product.

## 1.3 General Safety Instructions

Adhere to the applicable regulations and take the necessary precautions for all work you are going to do and consider the safety instructions in this document.



### DANGER



Caution: mains voltage

Contact with live parts is extremely hazardous when any objects are introduced or any liquids penetrate into the unit.

Make sure no objects enter through the louvers and no liquids penetrate into the equipment.

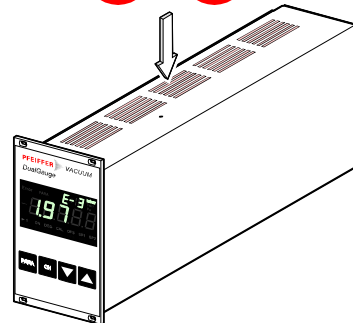

Communicate the safety instructions to all other users.

## **1.4 Liability and Warranty**

Pfeiffer Vacuum assumes no liability and the warranty becomes null and void if the end-user or third parties





- disregard the information in this document
- use the product in a non-conforming manner
- make any kind of interventions (modifications, alterations etc.) on the product
- use the product with accessories not listed in the corresponding product documentation.











## 2 Technical Data

Mains specifications	Voltage	90 ... 250 VAC
	Frequency	50 ... 60 Hz
	Power consumption	≤45 W
	Overvoltage category	II
	Protection class	1
	Connection	European appliance connector IEC 320 C14
Ambiance	Temperature storage	-20 ... +65 °C
	operation	+ 5 ... +50 °C
	Relative humidity	≤80% up to +31 °C, decreasing to 50% at +40 °C
	Use	indoors only max. altitude 2000 m NN
	Pollution degree	II
	Protection type	IP30
Compatible gauges	Number	2
	Compatible Compact Gauges	
	Pirani	TPR 261, TPR 265, TPR 280, TPR 281
	Pirani Capacitance	PCR 260
	Cold Cathode	IKR 251, IKR 261, IKR 270
	FullRange™ CC	PKR 251, PKR 261
	Process Ion	IMR 265
	FullRange™ BA	PBR 260
	Capacitance	CMR 261 ... CMR 275
	Piezo	APR 250 ... APR 267
Gauge connections	Number	2 (1 per channel)
	sensor connector	Amphenol C91B appliance connector, female, 6-pole (pin assignment →  20)

Gauge supply	Voltage Current Power Fuse protection	+24 VDC $\pm 5\%$ 750 mA 18 W 900 mA with PTC element, self-resetting after turning the TPG 262 off or disconnecting the gauge. The supply conforms to the requirements of a grounded protective extra low voltage (SELV-E according to EN 61010).
Operation	Front panel Remote control	via 4 keys via RS232C interface
Measurement values	Measurement ranges  Measurement error gain error offset error  Measurement rate Display rate Filter time constant slow normal (nor) fast  Measurement units Offset correction  Calibration factor   A/D converter	depending on gauges ( $\rightarrow$  [1] ... [14])  $\leq 0.01\%$ F.S. $\leq 0.01\%$ F.S.  50 / s 10 / s  1.2 s ( $f_g = 0.13$ Hz) 400 ms ( $f_g = 0.4$ Hz) 20 ms ( $f_g = 8$ Hz)  mbar, Pa, Torr -5 ... 110% F.S.  for logarithmic gauges 0.10 ... 9.99 for linear gauges 0.500 ... 2.000  resolution 0.001% F.S.

Switching functions	Number	4 (user-assignable)
	Reaction delay	≤20 ms if switching threshold close to measurement value (for larger differences consider filter time constant).
	Adjustment range	depending on gauge (→  [1] ... [14])
	Hysteresis	≥1% F.S. for linear gauges, ≥10% of measurement value for logarithmic gauges
Switching function relays	Contact type	floating changeover contact
	Load max.	30 VAC, 30 W (ohmic) 60 VDC, 1 A, 30 W (ohmic)
	Service life mechanic electric	5×10 <sup>7</sup> cycles 1×10 <sup>5</sup> cycles (at max. load)
	Contact positions	→  22
	Relay connector	D-Sub appliance connector, female, 15-pole (pin assignment →  22)
Error signal	Number	1
	Reaction time	≤20 ms
Error signal relay	Contact type	floating normally open contact
	Load max.	30 VAC, 30 W (ohmic) 60 VDC, 1 A, 30 W (ohmic)
	Service life mechanic electric	5×10 <sup>7</sup> cycles 1×10 <sup>5</sup> cycles (at max. load)
	Contact positions	→  21
	Control connector	Amphenol C91B appliance connector, female, 7-pole (pin assignment →  21)

Gauge control	Automatic	<b>Auto</b>
	ON setpoint	adjustable (→  50)
	OFF setpoint	adjustable (→  52)
	Manual	<b>Hand</b>
	via keys	
	activation/deactivation	(→  28, 49, 51)
	External	<b>Extern</b>
	via <i>control</i> connector	
	ON condition	signal ≤ +0.8 VDC
	OFF condition	signal +2.0 ... 5 VDC or input open
Hotstart	<b>Hot</b>	
when mains power on	(→  50)	
Self control	<b>SELF</b>	
deactivation when pressure is rising		
OFF threshold	adjustable (→  52)	
<i>Control</i> connector	Amphenol C91B appliance connector, female, 7-pole (pin assignment →  21)	
Analog outputs	Number	2 (1 per channel)
	Voltage range	0 ... +10 VDC
	Internal resistance	660 Ω
	Measuring signal vs. pressure	depending on gauge (→  [1] ... [14])
	<i>Control</i> connector	Amphenol C91B appliance connector, female, 7-pole (pin assignment →  21)
	Interface	Standard
Protocol		ACK/NAK, ASCII with 3-character mnemonics, bi-directional data flow, 8 data bits, no parity bit, 1 stop bit
RS232C		only TXD and RXD used
Transmission rate		9600, 19200, 38400 baud
RS232 connector		D-Sub appliance connector, male, 9-pole (pin assignment →  23)

Dimensions [mm]

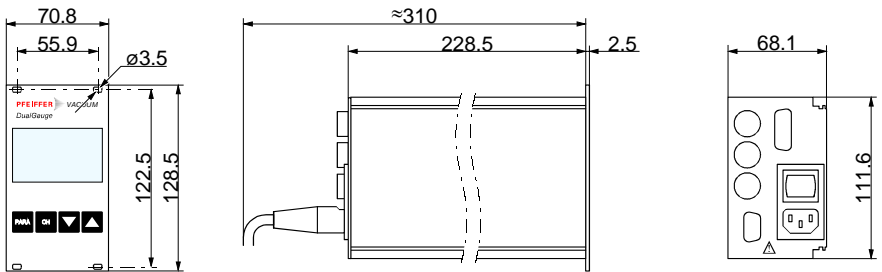

Use

For incorporation into a rack or control panel or as desk-top unit.

Weight

1.06 kg

## 3 Installation

### 3.1 Personnel



**Skilled personnel**



The unit may only be installed by persons who have suitable technical training and the necessary experience.

### 3.2 Installation, Setup

The TPG 262 is suited for incorporation into a 19" rack or a control panel or for use as desk-top unit.



**DANGER**



Caution: damaged product  
Putting a damaged product into operation can be extremely hazardous.  
In case of visible damages, make sure the product is not put into operation.

#### 3.2.1 Rack Installation

The TPG 262 is designed for installation into a 19" rack chassis adapter according to DIN 41 494. For this purpose, four collar screws and plastic sleeves are supplied with it.



**DANGER**



Caution: protection class of the rack  
If the product is installed in a rack, it is likely to lower the protection class of the rack (protection against foreign bodies and water) e.g. according to the EN 60204-1 regulations for switching cabinets.  
Take appropriate measures for the rack to meet the specifications of the protection class.

### Guide rail

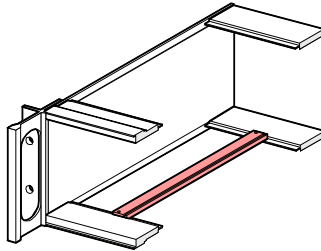
In order to reduce the mechanical strain on the front panel of the TPG 262, preferably equip the rack chassis adapter with a guide rail.



### Slide rails

For safe and easy installation of heavy rack chassis adapters, preferably equip the rack frame with slide rails.

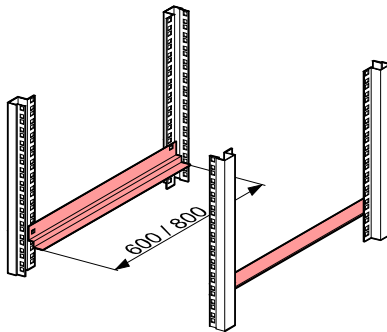

Height 3 U rack chassis adapter

- 1 Secure the rack adapter in the rack frame.



The admissible maximum ambient temperature (→ 9) must not be exceeded neither the air circulation obstructed.

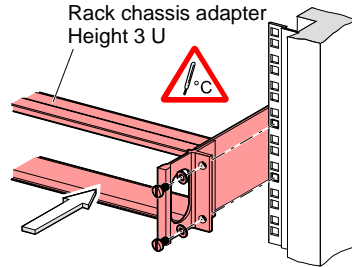

- 2 Slide the TPG 262 into the rack chassis adapter ...

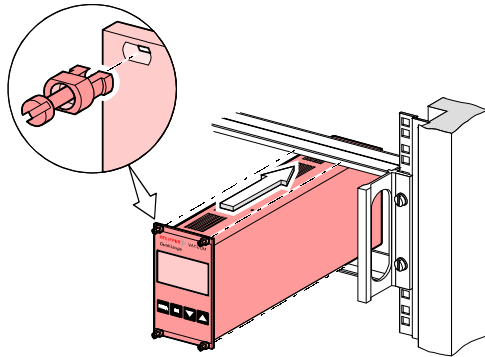

... and fasten the adapter panel to the rack chassis adapter using the screws supplied with the TPG 262.



### 3.2.2 Installation in a Control Panel



**DANGER**



Caution: protection class of the control panel  
 If the product is installed in a control panel, it is likely to lower the protection class of the control panel (protection against foreign bodies and water) e.g. according to the EN 60204-1 regulations for switching cabinets.  
 Take appropriate measures for the control panel to meet the specifications of the protection class.

For mounting the TPG 262 into a control panel, the following cut-out is required:

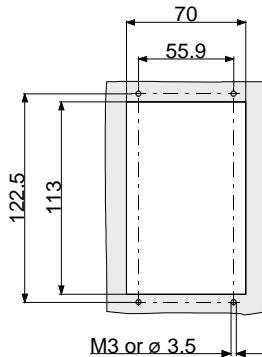

The admissible maximum ambient temperature (→ 9) must not be exceeded neither the air circulation obstructed.

For reducing the mechanical strain on the front panel, preferably support the unit.

- 1 Slide the TPG 262 into the cut-out of the control panel ...

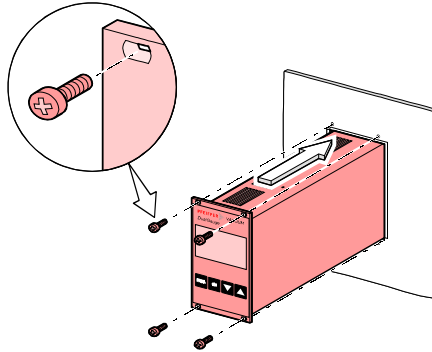

... and secure it with four M3 or equivalent screws.

### 3.2.3 Use as Desk-Top Unit

The TPG 262 is also suited for use as desk-top unit. For this purpose, two self-adhesive rubber feet as well as a slip-on rubber bar are supplied with it.

- 1 Stick the two supplied rubber feet to the rear part of the bottom plate ...

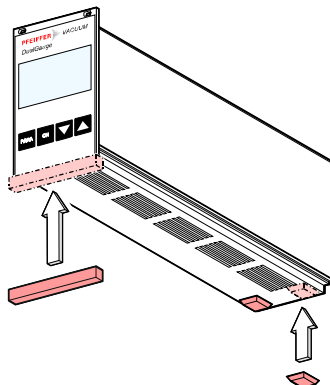

... and slip the supplied rubber bar onto the bottom edge of the front panel.



Select a location where the admissible maximum ambient temperature (→ 9) is not exceeded (e.g. due to sun irradiation).

### 3.3 Mains Power Connector



**DANGER**



Caution: line voltage

Incorrectly grounded products can be extremely hazardous in the event of a fault.

Use only a 3-conductor power cable with protective ground. The power connector may only be plugged into a socket with a protective ground. The protection must not be nullified by an extension cable without protective ground.

The unit is supplied with a power cord. If the mains connector is not compatible with your system, use your own, suitable cable with protective ground ( $3 \times 1.5 \text{ mm}^3$ ).



The socket must be fuse-protected with  $10 \text{ A}_{\text{max}}$

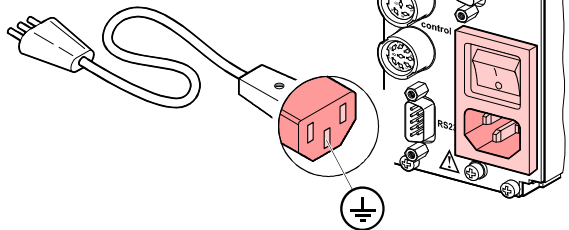

If the unit is installed in a switching cabinet, the mains voltage should be supplied and turned on via a central distributor.

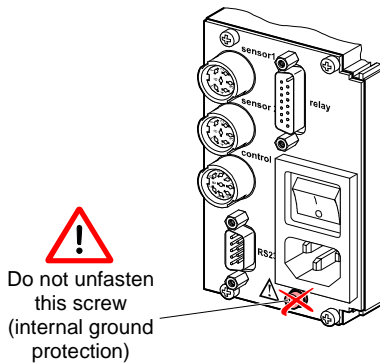

Do not unfasten this screw (internal ground protection)

### 3.4 Gauge Connectors *sensor 1, sensor 2*

For each measurement channel, there is a female appliance connector on the rear of the unit.



Connect the gauge to the *sensor* connector via a sensor cable set available from us (→ sales literature) or your own, screened (electromagnetic compatibility) sensor cable. Use compatible gauges only (→ 9).

Pin assignment *sensor 1, sensor 2*

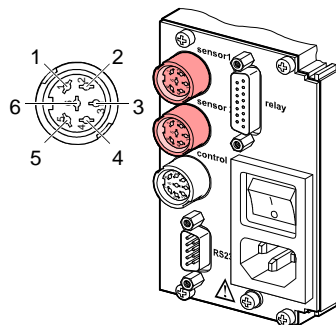

Pin assignment of the two female 6-pole Amphenol C91B appliance connectors:

Pin	Signal
1	Identification
6	Supply +24 VDC
2	Supply common GND
3	Signal input (measuring signal+)
4	Signal common (measuring signal-)
5	Screening

### 3.5 control Connector

This connector allows to read the measuring signal, to evaluate the state of the floating contacts of the error relay, and to activate or deactivate the gauges (→  47).





Connect the peripheral components to the *control* connector on the rear of the unit using your own, screened (electromagnetic compatibility) cable.

Pin assignment  
Contact positions  
*control*

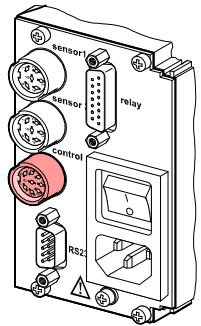
Pin assignment of the female 7-pole Amphenol C91B appliance connector:



Pin	Signal
2	Analog output gauge 1 0 ... 10 VDC
1	Analog output gauge 2 0 ... 10 VDC
5	Screening GND
4	Gauge 1 on signal $\leq +0.8$ VDC off signal +2.0 ... 5 VDC or input open
6	Gauge 2 on signal $\leq +0.8$ VDC off signal +2.0 ... 5 VDC or input open
3	 No error
7	 Error or power supply turned off

A suitable connector is supplied with the TPG 262.

### 3.6 relay Connector

This connector allows to use the floating switching contacts for an external control system.



Connect the peripheral components to the *relay* connector on the rear of the unit using your own, screened (electromagnetic compatibility) cable.

Pin assignment  
Contact positions  
*relay*

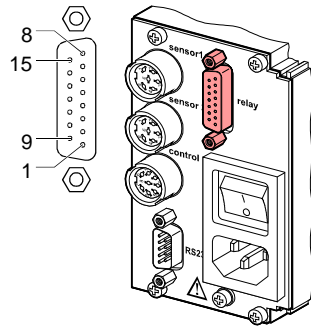

Pin assignment of the female 15-pole D-Sub appliance connector:

Pin	Signal			
	Switching function 1 <b>SP1</b>			
4		Pressure below threshold		Pressure above threshold or power supply turned off
3				
2				
	Switching function 2 <b>SP2</b>			
7		Pressure below threshold		Pressure above threshold or power supply turned off
6				
5				
	Switching function 3 <b>SP3</b>			
11		Pressure below threshold		Pressure above threshold or power supply turned off
10				
9				
	Switching function 4 <b>SP4</b>			
14		Pressure below threshold		Pressure above threshold or power supply turned off
13				
12				
	Supply for relays with higher switching power			
15	+24 VDC, 200 mA			Fuse-protected at 300 mA with PTC element, self-resetting after power off or pulling the <i>relay</i> connector. Meets the requirements of a grounded protective extra low voltage (SELV-E according to EN 61010).
1				
8				
	GND			
	GND			



## 4 Operation

### 4.1 Front Panel

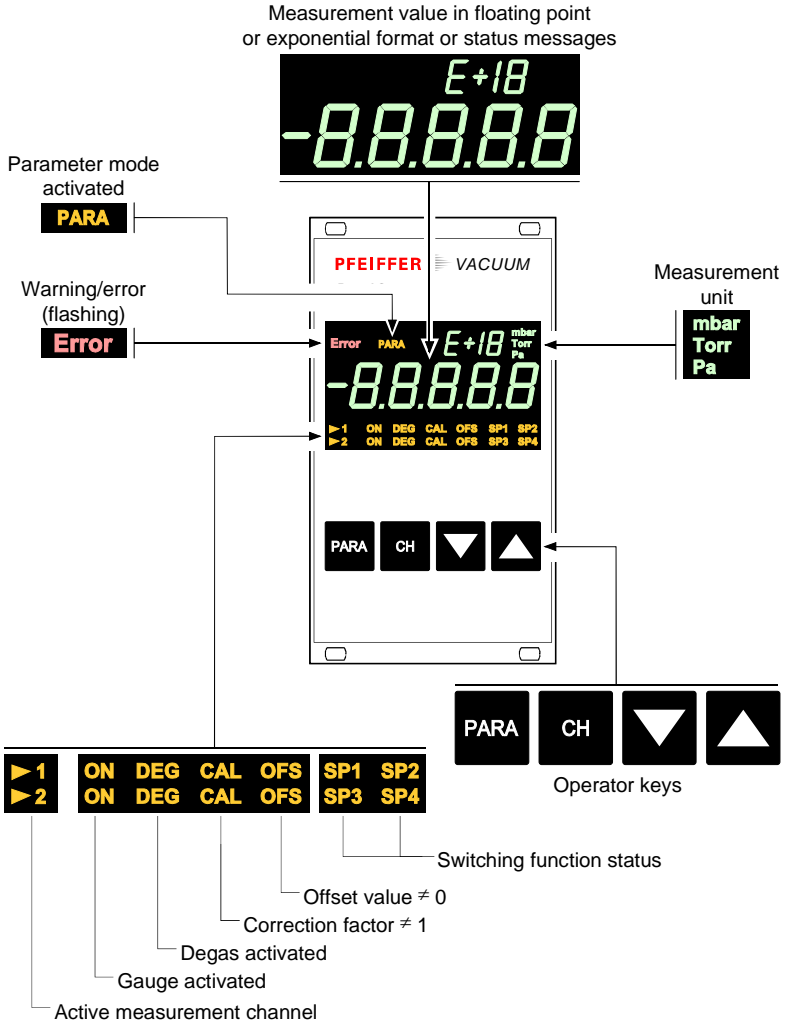



## 4.2 Turning the TPG 262 On and Off

Make sure the TPG 262 is correctly installed and the specifications in the Technical Data are met.

Turning the TPG 262 on

The power switch is on the rear of the unit.

Turn the TPG 262 on with the power switch (or centrally, via a switched power distributor, if the unit is incorporated in a rack).

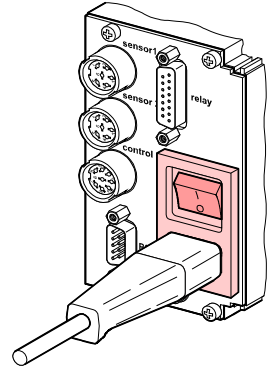

After power on, the TPG 262 ...

- automatically performs a self-test
- identifies the connected gauge
- activates the parameters that were in effect before the last power off
- switches to the Measurement mode
- adapts the parameters if required (if another gauge was previously connected).

Turning the TPG 262 off









Turn the TPG 262 off with the power switch (or centrally, via a switched power distributor, if the unit is incorporated in a rack).



Wait at least 10 s before turning the TPG 262 on again in order for it to correctly initialize itself.

### 4.3 Operating Modes

The TPG 262 works in the following operating modes:

- Measurement mode  
for displaying measurement values or statuses  
(→  27)
- Parameter mode  
for displaying or editing parameters (→  31)
  - Switching function parameter group **SP-P**  
for entering or displaying thresholds (→  33)
  - Gauge parameter group **SEN-P**  
for entering or displaying gauge parameters  
(→  38)
  - Gauge control group **CTL-P**  
for entering or displaying gauge control parameters (→  47)
  - General parameter group **GEN-P**  
for entering or displaying general parameters  
(→  54)
  - Test program group **TEST**  
for running internal test programs (→  58)
- Program transfer mode  
for updating the firmware (→  99)

### 4.4 Measurement mode

The Measurement mode is the standard operating mode of the TPG 262. Measurement values and statuses as well as the gauge identification are displayed in this mode.

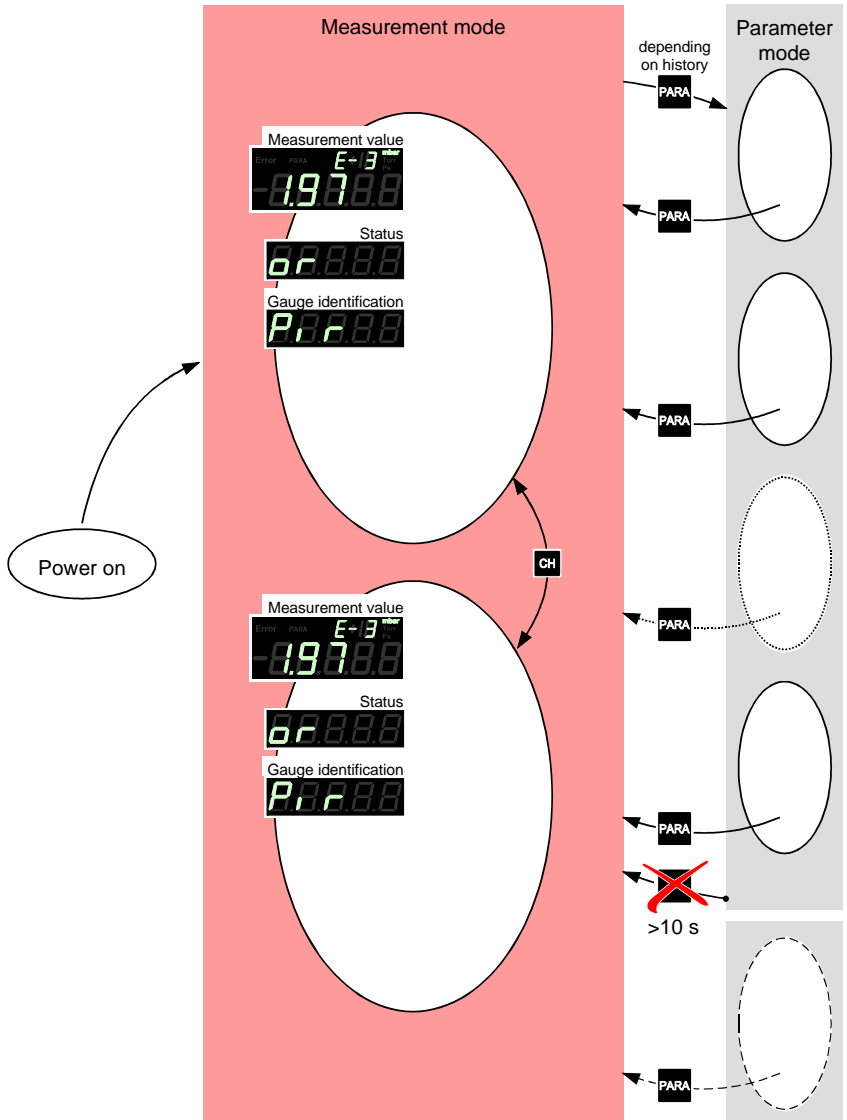

Selecting a measurement channel



⇒ Channel 1 is activated



⇒ Channel 2 is activated



Turning a gauge on and off

Certain gauges can be turned on and off manually, if the gauge control is set to **HRnd** (→ 51).

Available for:

- Pirani Gauge (TPR)
- Pirani Capacitance Gauge (PCR)
- Cold Cathode Gauge (IKR)
- FullRange™ CC Gauge (PKR)
- Process Ion Gauge (IMR)
- FullRange™ BA Gauge (PBR)
- Capacitance Gauge (CMR)
- Piezo Gauge (APR)

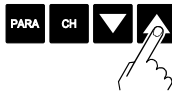

⇒ Press key >1 s:  
The gauge is turned off.  
**OFF** is displayed instead of the measurement value.

**ON**

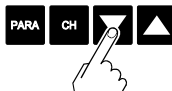

⇒ Press key >1 s:  
The gauge is turned on. A status message may be displayed instead of the measurement value.



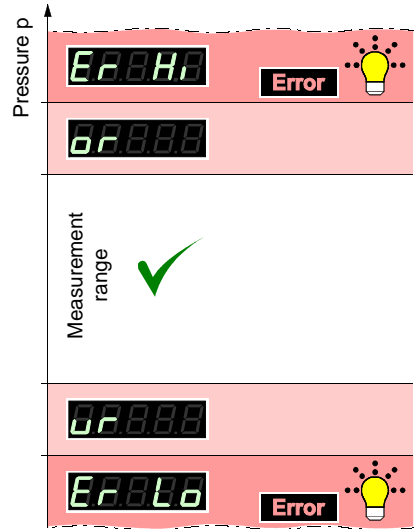

Displaying the gauge identification

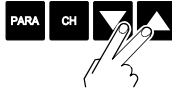

⇒ Press keys >0.5 s:  
The type of the connected gauges is automatically identified and displayed for 4 s (2 s per channel):

Pirani Gauge (TPR 261, TPR 265, TPR 280, TPR 281) Pirani Capacitance Gauge <sup>1)</sup> (PCR 260)	}	
Cold Cathode Gauge (IKR251, IKR261)		
Cold Cathode Gauge (IKR270)		
FullRange™ CC Gauge (PKR251, PKR261)		
Process Ion Gauge (IMR265)		
FullRange™ BA Gauge (PBR260)		
Capacitance Gauge (CMR261 ... CMR275)	}	
Piezo Gauge (APR250 ... APR267)		
No gauge connected (no Sensor)		
Connected gauge cannot be identified (no Identifier)		

<sup>1)</sup> TPR and PCR have identical identifiers. In the TPG 262, there is no distinction made on the display and in data evaluation, since pressure ranges of these gauges are approximately the same.

Getting to the Parameter mode



→ 31

## 4.5 Parameter Mode

The Parameter mode is used for displaying, editing and entering parameter values as well as for testing the TPG 262. For ease of operation, the parameters are divided into groups.

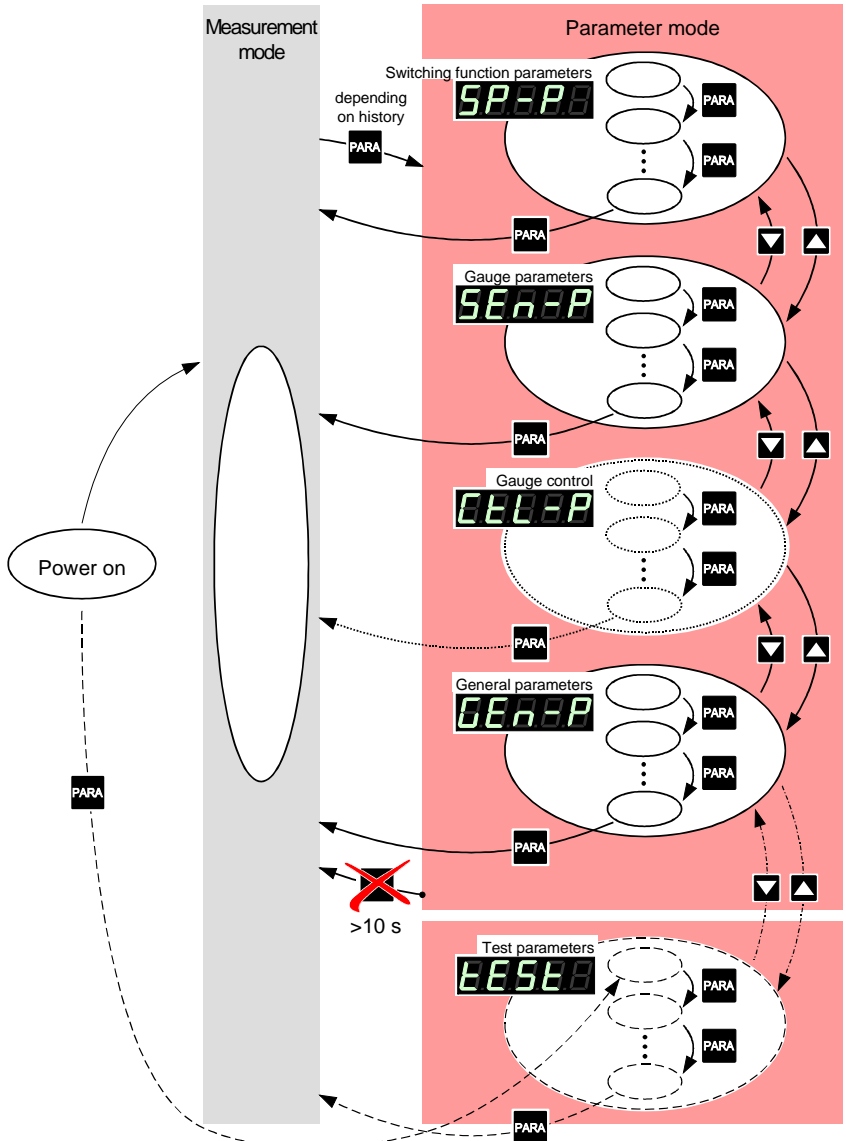

Selecting a parameter group

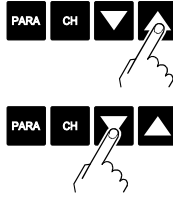

- ⇒ Switching function parameters → 33
- Gauge parameters → 38
- Gauge control → 47
- General parameters → 54
- Test parameters → 58

Selecting a parameter in a parameter group



Editing a parameter in a parameters group

Modifications of parameters come into effect immediately and are stored automatically. Exceptions are mentioned under the corresponding parameters.



### 4.5.1 Switching Function Parameters



The switching function parameter group (setpoint parameters) is used for displaying, entering and editing threshold values and assigning the four switching functions to a measurement channel.

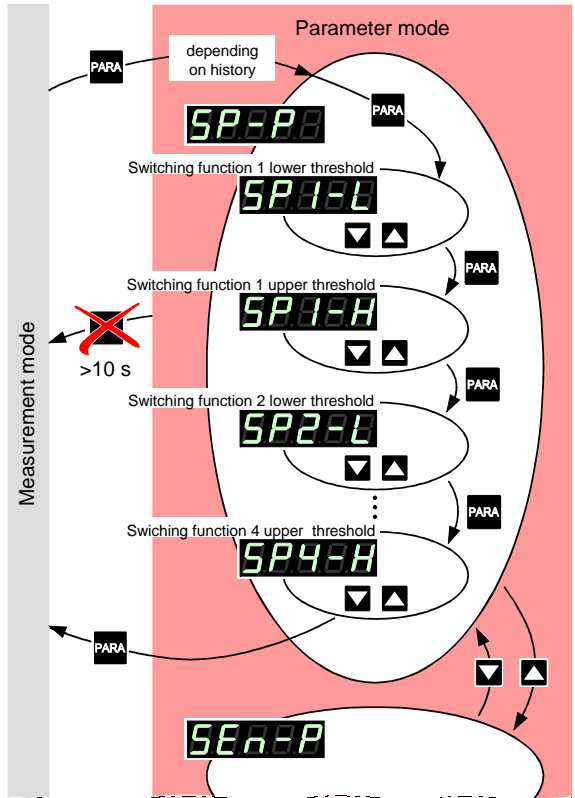

The TPG 262 has four switching functions with two adjustable thresholds each. The status of the switching function is displayed on the front panel (→ 24, 21) and can be evaluated via the floating contacts at the *Control* connector.

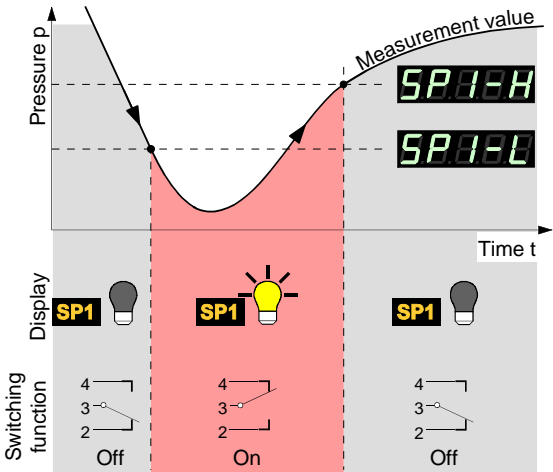

Selecting a parameter



⇒ The name of the parameter,

e.g.: **SP1-L**

Switching function 1  
lower setpoint

is displayed as long as the key is pressed or at least for 1.5 s.

Afterwards, the currently valid threshold value is displayed.



### Editing the threshold value

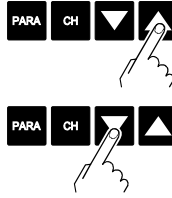

⇒ Press key <1 s:  
The value is increased/  
decreased by 1 increment.

Press key >1 s:  
The value is increased/  
decreased continuously.

### Limits of the lower switching thresholds



#### Value

The lower switching threshold (Setpoint low) defines the pressure at which the switching function is activated when the pressure is dropping.

⇒ gauge dependent  
(→ table).

If another gauge type is connected, the TPG 262 automatically adjusts the switching threshold if required.

	lower threshold limit 	upper threshold limit 
	$5 \times 10^{-4}$	1500
	$1 \times 10^{-9}$	$1 \times 10^{-2}$
	$1 \times 10^{-11}$	$1 \times 10^{-2}$
	$1 \times 10^{-9}$	1000
	$1 \times 10^{-6}$	1000
	$5 \times 10^{-10}$	1000
	F.S. / 1000	F.S.

all values in mbar, CAL=1



The minimum hysteresis between the upper and lower switching threshold is at least 10% of the lower threshold or 1% of the set full scale value. If the value of the minimum hysteresis drops below these values, the upper threshold is automatically adjusted to a minimum hysteresis. This prevents unstable states.

Limits of the upper switching thresholds



Value

The upper switching threshold (Setpoint high) defines the pressure at which the switching function is deactivated when the pressure is rising.

⇒ Gauge dependent (→ table).

If another gauge type is connected, the TPG 262 automatically adjusts the threshold if required.

	lower threshold limit	upper threshold limit
	+10% lower threshold	1500
	+10% lower threshold	$1 \times 10^{-2}$
	+10% lower threshold	$1 \times 10^{-2}$
	+10% lower threshold	1000
	+10% lower threshold	1000
	+10% lower threshold	1000
	+1% measurement range (F.S.)	F.S.

all values in mbar, CAL=1



The minimum hysteresis between the upper and lower switching threshold is at least 10% of the lower threshold or 1% of the set full scale value. If the value of the minimum hysteresis drops below these values, the upper threshold is automatically adjusted to a minimum hysteresis. This prevents unstable states.

### Assigning a switching function

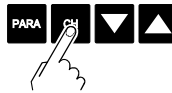

⇒ Switching function is assigned to channel 1.



⇒ Switching function is assigned to channel 2.



The lower **SP<sub>LOW</sub>** and the upper **SP<sub>HIGH</sub>** switching threshold of a switching function are always assigned to the same channel. The last assignment is valid for both thresholds.

### 4.5.2 Gauge Parameters



The Gauge parameter group (sensor parameters) is used for displaying, entering and editing parameters of the connected gauges.

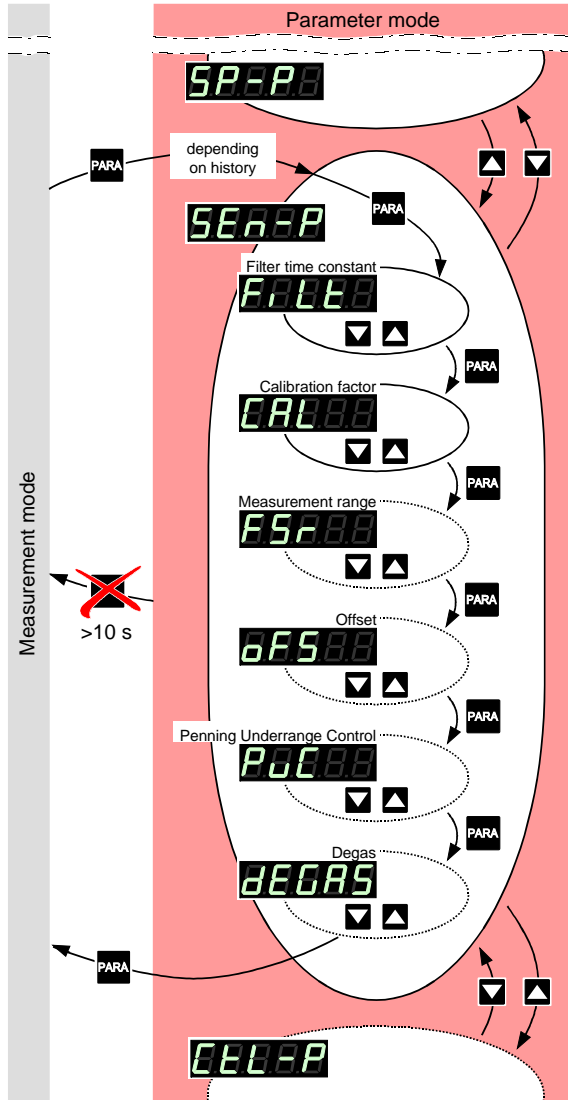

### Selecting a parameter



⇒ The name of the parameter,

e.g.: **FILTE**

Filter time constant

is displayed as long as the key is pressed or at least for 1.5 s.

Afterwards, the currently valid threshold value is displayed.

Some parameters are not available for all gauges and thus not always displayed.

→ 39 41 42 43 44 46

	39	41	42	43	44	46
<b>FILTE</b>	✓	✓	—	—	—	—
<b>PE9</b>	✓	✓	—	—	✓	—
<b>PE11</b>	✓	✓	—	—	✓	—
<b>CO9</b>	✓	✓	—	—	—	—
<b>10A6</b>	✓	✓*)	—	—	—	—
<b>10A12</b>	✓	✓*)	—	—	—	✓
<b>11A</b>	✓	✓	✓	✓	—	—

\*) depending on pressure

### Measurement value filter

The measurement value filter permits a better evaluation of unstable or disturbed measuring signals.



The measurement value filter does not affect the analog output (→ 21).

Value

FALEB

FASEB

⇒ Fast:  
The TPG 262 responds quickly to fluctuations of the measurement value. As a result, it will respond faster to interference in the measured values.

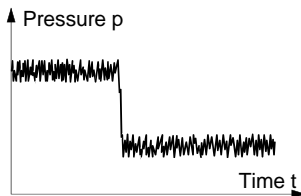

NOFEB

⇒ Normal:  
Good relationship between response and sensitivity of the display and the switching function to changes in the measured values.

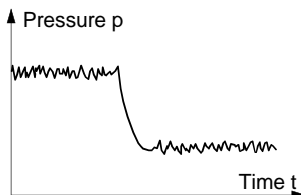

SLFEB

⇒ Slow:  
The TPG 262 does not respond to small changes in measured values. As a result, it will respond more slowly to changes in the measured values.

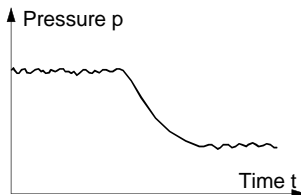



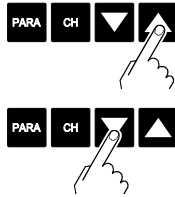

⇒ The value is increased/ decreased by the defined increments.

### Calibration factor





The calibration factor allows the measured value to be calibrated for other gases than N<sub>2</sub> (→ characteristic curves in [1] ... [12]).

Available for:

- Pirani Gauge (TPR)
- Pirani Capacitance Gauge (PCR)
- Cold Cathode Gauge (IKR)
- FullRange™ CC Gauge (PKR)
- Process Ion Gauge<sup>\*)</sup> (IMR)
- FullRange™ BA Gauge<sup>\*\*)</sup> (PBR)
- Capacitance Gauge (CMR)
- Piezo Gauge (APR)

<sup>\*)</sup> only for pressures <math>1 \times 10^{-2}</math> mbar.

<sup>\*\*)</sup> only for pressures <math>1 \times 10^{-1}</math> mbar.

	Value
	<div style="text-align: right;"><b>CAL</b></div> <p>⇒ No correction </p> <p>⇒ Measurement value corrected by a factor of 0.10 ... 9.99 (logarithmic gauges). Measurement value corrected by a factor of 0.500 ... 2.000 (linear gauges). </p>
e.g.: 	
e.g.: 	

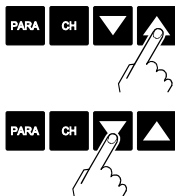

⇒ Press key <1 s:  
The value is increased/  
decreased by 1 increment.



Press key >1 s:  
The value is increased/  
decreased continuously.

### Measurement range (F.S.) of linear gauges

For linear gauges, the full scale (F.S.) value has to be defined according to the connected gauge type. For logarithmic gauges it is automatically recognized.

Available for:

- Pirani Gauge (TPR)
- Pirani Capacitance Gauge (PCR)
- Cold Cathode Gauge (IKR)
- FullRange™ CC Gauge (PKR)
- Process Ion Gauge (IMR)
- FullRange™ BA Gauge (PBR)
- Capacitance Gauge (CMR)
- Piezo Gauge (APR)

	Value
 e.g.: 	⇒ 0.01 mbar 0.1 mbar 1 mbar 10 mbar 100 mbar 1000 mbar 2 bar 5 bar 10 bar 50 bar Conversion table → Appendix 97

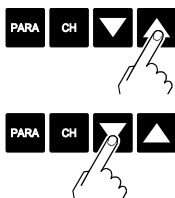

⇒ The value is increased/  
decreased by the defined in-  
crements.

## Offset correction

The offset value is displayed and readjusted according to the actual measurement value (in the range of -5 ... +110% of the set full scale value).

Available for:

- Pirani Gauge (TPR)
- Pirani Capacitance Gauge (PCR)
- Cold Cathode Gauge (IKR)
- FullRange™ CC Gauge (PKR)
- Process Ion Gauge (IMR)
- FullRange™ BA Gauge (PBR)
- Capacitance Gauge (CMR)
- Piezo Gauge (APR)

The offset correction affects:

- the displayed measurement value
- the displayed threshold value of the switching functions
- the analog outputs at the *control* connector (→ 21)

	Value
	⇒ Offset correction deactivated
e.g.:	⇒ Offset correction activated
	⇒ Press key >1.5 s: The offset value is readjusted. The actual measurement value is accepted as new offset value.
	⇒ Reset the offset value.

When the offset correction is activated, the saved offset value is subtracted from the actual measurement value. This allows measuring relative to a reference pressure.



When the zero of the gauge is readjusted, the offset correction must be deactivated.

Underrange control

Behavior in the event of an underrange with Cold Cathode Gauges (Penning underrange control).

Available for:

- Pirani Gauge (TPR)
- Pirani Capacitance Gauge (PCR)
- Cold Cathode Gauge (IKR)
- FullRange™ CC Gauge (PKR)
- Process Ion Gauge (IMR)
- FullRange™ BA Gauge (PBR)
- Capacitance Gauge (CMR)
- Piezo Gauge (APR)

There is a number of possible causes of an underrange:

- the pressure in the vacuum system is lower than the measurement range
- the measurement element has not ignited (yet)
- the discharge has failed
- a defect has occurred

**Caution**

Caution: relay is switching  
 An underrange can lead to unintended reactions of the connected control system.  
 Prevent false control signals and messages by disconnecting the sensor and control cables.

	Value
	<p>⇒ Underrange state is interpreted as admissible measurement value. <b>0FFF0</b> is displayed. The switching function remains ON.</p>
	<p>⇒ Underrange state is interpreted as inadmissible measurement value. <b>0n000</b> is displayed. The switching function changes to OFF.</p>

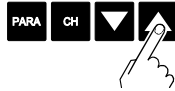

⇒ Activate/deactivate the underrange control.

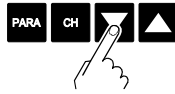

If chances are that the pressure in the vacuum system drops below the measurement range of the gauge, it is advisable to select **OFF**.

If **on** is selected, the evaluation of the switching function is suppressed for approx. 10 seconds when the gauge is turned on and each time after an underrange has occurred. During this time, the switching function remains OFF.

## Degas

Contamination deposits on the electrode system of hot cathode gauges may cause instabilities of the measurement values. The Degas function allows to clean the electrode system.

Available for:

- Pirani Gauge (TPR)
- Pirani Capacitance Gauge (PCR)
- Cold Cathode Gauge (IKR)
- FullRange™ CC Gauge (PKR)
- Process Ion Gauge (IMR)
- FullRange™ BA Gauge (PBR)
- Capacitance Gauge (CMR)
- Piezo Gauge (APR)

	Value
	⇒ Normal operation.
	⇒ Degas: The electron collection grid is heated to $\approx 700\text{ }^{\circ}\text{C}$ by electron bombardment and the electrode system is thus cleaned.
	⇒ Start Degas. Duration of the Degas function 3 min. (can be aborted).
	⇒ Abort Degas.

**DEG**

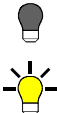

### 4.5.3 Gauge Control



The Gauge control group (control parameters) is used for displaying, entering and editing parameters which define how the connected gauges are activated/ deactivated.



If the connected gauges cannot be controlled (→ 49), this group is not available.

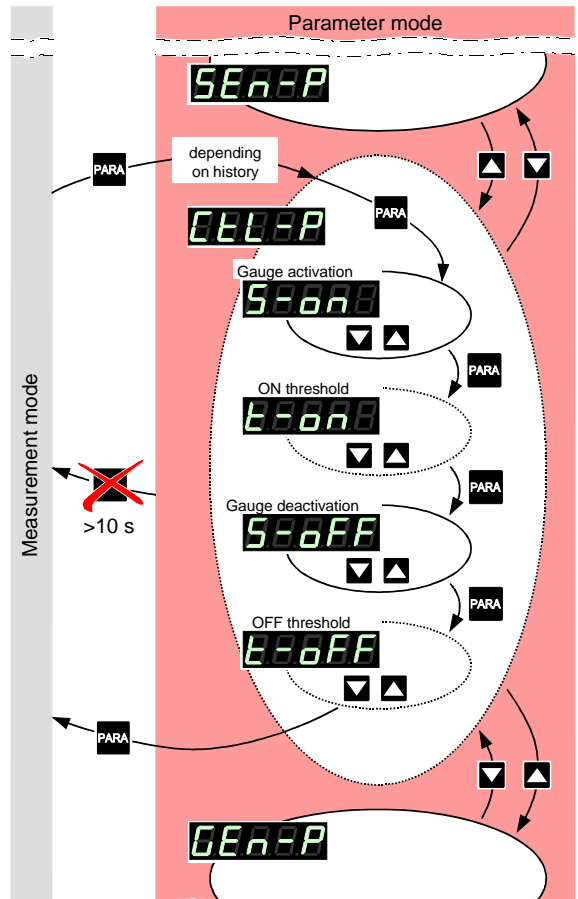

Selecting a parameter



⇒ The name of the parameter,

e.g.: **S-ON**

Gauge activation

is displayed as long as the key is pressed or at least for 1.5 s.

Afterwards, the currently valid threshold value is displayed.

Some parameters are not available for all gauges and thus not always displayed.

→ 49 50 51 52

	49	50	51	52
	<b>S-ON</b>	<b>E-ON</b>	<b>S-OFF</b>	<b>E-OFF</b>
Available for	<b>PR</b>	-	-	-
	<b>PE9</b>	✓	✓	✓
	<b>PE11</b>	✓	✓	✓
	<b>Co9</b>	✓	-	✓
	<b>LoN6</b>	✓	✓	✓
	<b>LoN12</b>	✓	✓	✓
	<b>LN</b>	-	-	-









## Gauge activation

Certain gauges can be activated by different means.

The following gauges can be controlled:

- Pirani Gauge (TPR)
- Pirani Capacitance Gauge (PCR)
- Cold Cathode Gauge (IKR)
- FullRange™ CC Gauge <sup>\*)</sup> (PKR)
- Process Ion Gauge (IMR)
- FullRange™ BA Gauge (PBR)
- Capacitance Gauge (CMR)
- Piezo Gauge (APR)

<sup>\*)</sup> except by a gauge connected to the other measurement channel

	Value
	<p>⇒ Automatic activation: The gauge is activated by one of the following gauges connected to the other measurement channel.</p> <ul style="list-style-type: none"> <li><input checked="" type="checkbox"/> Pirani Gauge (TPR)</li> <li><input checked="" type="checkbox"/> Pirani Capacitance Gauge (PCR)</li> <li><input type="checkbox"/> Cold Cathode Gauge (IKR)</li> <li><input checked="" type="checkbox"/> FullRange™ CC Gauge (PKR)</li> <li><input checked="" type="checkbox"/> Process Ion Gauge (IMR)</li> <li><input checked="" type="checkbox"/> FullRange™ BA Gauge (PBR)</li> <li><input checked="" type="checkbox"/> Capacitance Gauge <sup>*)</sup> (CMR)</li> <li><input checked="" type="checkbox"/> Piezo Gauge <sup>*)</sup> (APR)</li> </ul> <p><sup>*)</sup> only gauges with F.S. 1, 10 or 100 mbar</p>
	<p>⇒ Manual activation: The gauge is activated by pressing the  key.</p>
	<p>⇒ External activation: The gauge is activated by an input signal fed via the <i>control</i> connector (→  21).</p>
	<p>⇒ Hot start: The gauge is automatically activated when the TPG 262 is turned on. Measurement is thus automatically resumed after a power failure. Gauge deactivation →  51.</p>

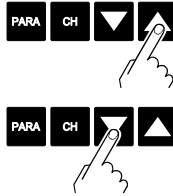

⇒ Increase/decrease the value by the defined increments.

### ON threshold

Definition of the ON threshold for the gauge to be activated by a gauge connected to the other measurement channel.

Available for:

- Pirani Gauge (TPR)
- Pirani Capacitance Gauge (PCR)
- Cold Cathode Gauge (IKR)
- FullRange™ CC Gauge (PKR)
- Process Ion Gauge (IMR)
- FullRange™ BA Gauge (PBR)
- Capacitance Gauge (CMR)
- Piezo Gauge (APR)

### Adjustment range



e.g.:

→ table below

	TPR PCR	PKR IMR PBR	CMR, APR		
			F.S.=1	F.S.=10	F.S.=100
IKR	$10^{-3} \dots 10^{-2}$	$10^{-5} \dots 10^{-2}$	$10^{-3} \dots 10^{-2}$	—	—
IMR	$10^{-3} \dots 1$	$10^{-5} \dots 1$	$10^{-3} \dots 1$	$10^{-2} \dots 1$	$10^{-1} \dots 1$
PBR	$10^{-3} \dots 1$	$10^{-5} \dots 1$	$10^{-3} \dots 1$	$10^{-2} \dots 1$	$10^{-1} \dots 1$

all values in mbar, CAL=1



Value **E-00FF** must be  $\geq$  **E-0000**.

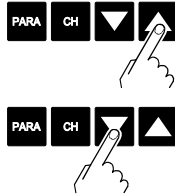

⇒ Press key <1 s:  
The value is increased/  
decreased by 1 increment.

Press key >1 s:  
The value is increased/  
decreased continuously.

**Gauge deactivation** Certain gauges can be deactivated by different means.

The following gauges can be controlled:

- Pirani Gauge (TPR)
- Pirani Capacitance Gauge (PCR)
- Cold Cathode Gauge (IKR)
- FullRange™ CC Gauge <sup>\*)</sup> (PKRx)
- Process Ion Gauge <sup>\*)</sup> (IMR)
- FullRange™ BA Gauge <sup>\*)</sup> (PBR)
- Capacitance Gauge (CMRx)
- Piezo Gauge (APR)

<sup>\*)</sup> except for self control

<sup>\*\*)</sup> except by a gauge connected to the other measurement channel

	Value
	<p>⇒ Automatic deactivation: The gauge is deactivated by one of the following gauges connected to the other measurement channel.</p> <ul style="list-style-type: none"> <li><input checked="" type="checkbox"/> Pirani Gauge (TPR)</li> <li><input checked="" type="checkbox"/> Pirani Capacitance Gauge (PCR)</li> <li><input type="checkbox"/> Cold Cathode Gauge (IKR)</li> <li><input checked="" type="checkbox"/> FullRange™ CC Gauge (PKR)</li> <li><input checked="" type="checkbox"/> Process Ion Gauge (IMR)</li> <li><input checked="" type="checkbox"/> FullRange™ BA Gauge (PBR)</li> <li><input checked="" type="checkbox"/> Capacitance Gauge <sup>*)</sup> (CMR)</li> <li><input checked="" type="checkbox"/> Piezo Gauge <sup>*)</sup> (APR)</li> </ul> <p><sup>*)</sup> only for gauges with F.S. 1, 10, or 100 mbar</p>
	<p>⇒ Manual deactivation: The gauge is deactivated by pressing the  key.</p>
	<p>⇒ External deactivation: The gauge is deactivated by an input signal via the <i>control</i></p>

Additionally for Cold Cathode Gauge:



connector (→ 21).

⇒ Self control:  
The gauge deactivates itself when the pressure rises (→ 52).

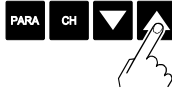

⇒ Increase/decrease the value by the defined increments.

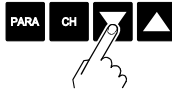

## OFF threshold

Definition of the OFF threshold for the gauge to be deactivated by a gauge connected to the other measurement channel or by itself.

Available for:

- Pirani Gauge (TPR)
- Pirani Capacitance Gauge (PCR)
- Cold Cathode Gauge (IKRx)
- FullRange™ CC Gauge (PKR)
- Process Ion Gauge (IMR)
- FullRange™ BA Gauge (PBR)
- Capacitance Gauge (CMR)
- Piezo Gauge (APR)

## Adjustment range



→ table below



e.g.:

	TPR PCR	PKR IMR PBR	CMR, APR		
			F.S.=1	F.S.=10	F.S.=100
IKR	$10^{-3} \dots 10^{-2}$	$10^{-5} \dots 10^{-2}$	$10^{-3} \dots 10^{-2}$	—	—
IMR	$10^{-3} \dots 1$	$10^{-5} \dots 1$	$10^{-3} \dots 1$	$10^{-2} \dots 1$	$10^{-1} \dots 1$
PBR	$10^{-3} \dots 1$	$10^{-5} \dots 1$	$10^{-3} \dots 1$	$10^{-2} \dots 1$	$10^{-1} \dots 1$

all values in mbar, CAL=1

 Value **E-0FF** must be  $\geq$  **E-0n**.

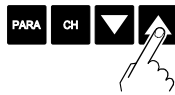

⇒ Press key <1 s:  
The value is increased/  
decreased by 1 increment.

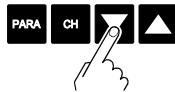

Press key >1 s:  
The value is increased/  
decreased continuously.

### 4.5.4 General Parameters



The General parameters group (**general parameters**) is used for displaying, entering and editing generally applicable system parameters.

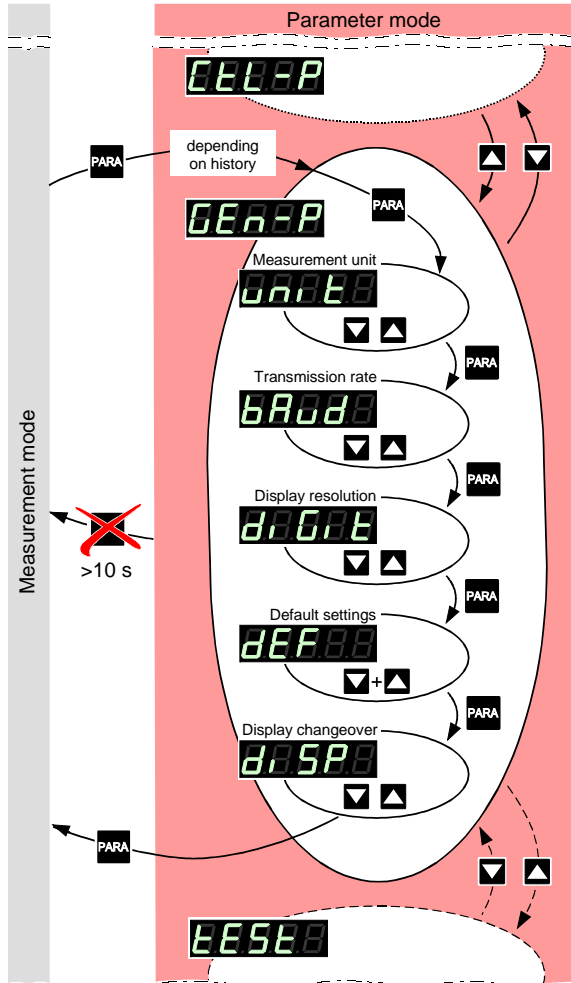

### Selecting a parameter



⇒ The name of the parameter,



e.g.: Measurement unit

is displayed as long as the key is pressed or at least for 1.5 s.

Afterwards, the currently valid threshold value is displayed.

The parameters are available for all gauge types and thus always displayed.

	→	56	56	56	57	57
Available for						
	all gauges	✓	✓	✓	✓	✓

### Editing a parameter





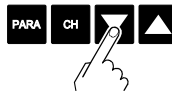





⇒ Increase/decrease the value by the defined increments.





Measurement unit

Unit of measured values, thresholds etc. See Appendix (→  97) for conversion.

	Value
	
 ⇒ mbar/bar	
 ⇒ Torr (only available if Torr lock is not activated i.e. Torr is not suppressed →  63)	
 ⇒ Pascal	







Transmission rate

Transmission rate of the RS232C interface.

	Value
	
e.g.:  ⇒ 9600 baud 19200 baud 38400 baud	

Display resolution (digits)

Display resolution of measured values.

	Value
	
 ⇒ Display	<ul style="list-style-type: none"> <li>• rounded to one decimal digit </li> <li>• or two integrals </li> </ul>
 ⇒ Display	<ul style="list-style-type: none"> <li>• rounded to two decimal digits </li> <li>• or three integrals </li> </ul>



### Default values

All user parameter settings are replaced by the factory settings.



Loading of the default parameter settings is irreversible.

	Value

⇒ The default values are loaded (→ 98).

### Display changeover

Definition of the measurement display behavior when a Pirani gauge or a Pirani Capacitance Gauge is combined with a linear gauge with F.S. 1000 mbar.

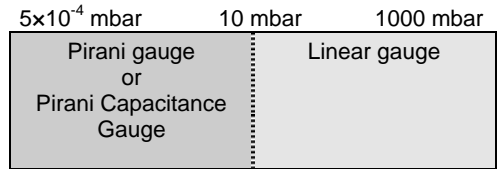

Automatic display changeover is available for this gauge combination only.

	Value
	<p>⇒ Manual change of measurement value display</p> <p>⇒ Automatic change of measurement value display when the measured value of the linear gauge drops below or rises above 10 mbar</p>

### 4.5.5 Test Parameters



The Test parameter group is used for displaying the firmware version, entering and editing special parameter values, and for running test programs.



This group is only available if the **PARA** key was pressed while the TPG 262 was turned on.

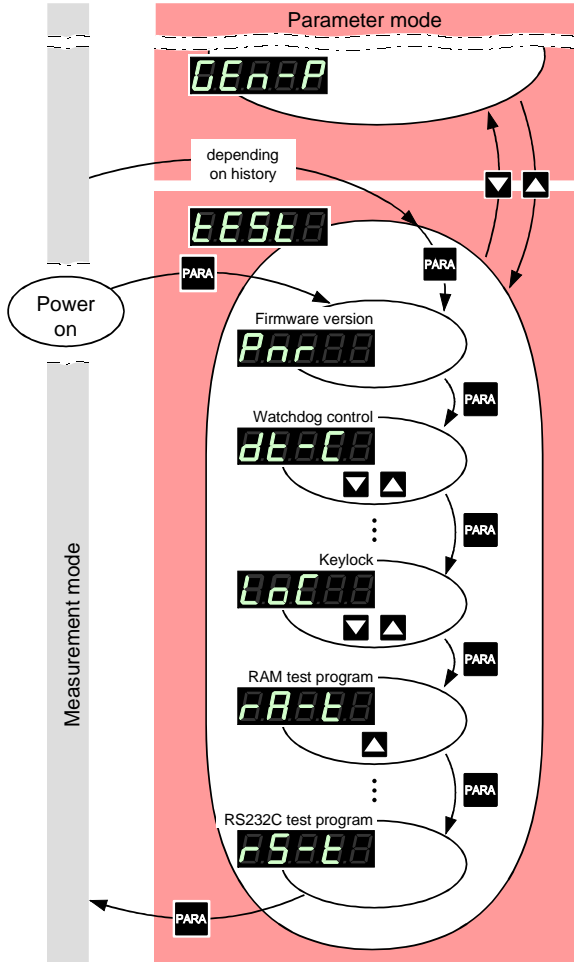

### Selecting a parameter



⇒ The name of the parameter,  
e.g.: **PAR00**  
Firmware version  
is displayed.

The parameters are available for all gauge types and thus always displayed.

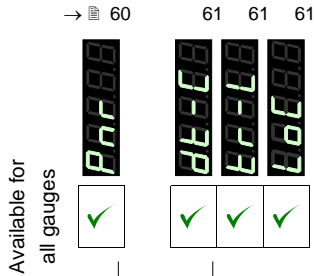

The name of the parameter is displayed as long as the key is pressed or at least for 1.5 s.

The firmware version is continuously displayed.

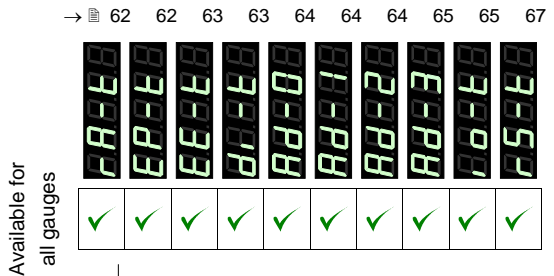

The name of the test program is displayed until it is started.

Editing a parameter

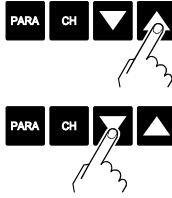

⇒ Increase/decrease the value by the defined increments.

Starting the test program

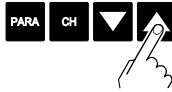

⇒ Start test program.

Firmware version

The firmware version (program version) is displayed.

	Version
	⇒ The two parts of the firmware number are displayed alternately.

The last character indicates the modification index (-, A ... Z). Please mention this index when contacting Pfeiffer Vacuum in the event of a problem.

Watchdog control

Behavior of the system control (watchdog) in the event of an error.

	Setting
	⇒ The system automatically acknowledges error messages of the watchdog after 2 s.
	⇒ Error messages of the watchdog have to be acknowledged by the operator.

Torr lock

The measurement unit **Torr** can be suppressed in the corresponding parameter setting **UNIT** (→ 56).

	Setting
	⇒ Measurement unit <b>Torr</b> available.
	⇒ Measurement unit <b>Torr</b> not available.





Keylock

The keylock function prevents inadvertent entries in the Parameter mode and thus malfunctions.

	Setting
	⇒ Keylock function disabled.
	⇒ Keylock function enabled. <b>0000</b> is displayed when the user attempts to edit a setting in the Parameter mode.





RAM test

Test of the main memory.

	Test sequence
	The test runs automatically one time:
	⇒ Test in process (very briefly).
	⇒ Test finished, no error found.
	⇒ Test finished, error(s) found. The <b>Error</b> lamp flashes.
	If the error message persists after several test sequences have been run, please contact your local Pfeiffer Vacuum service center.

EPROM test

Test of the program memory.

	Test sequence
	The test runs automatically one time:
	⇒ Test in process
	⇒ Test finished, no error found. After the test, a four-digit checksum (hexadecimal format) is displayed.
	⇒ Test finished, error(s) found. After the test, a four-digit checksum (hexadecimal format) is displayed. The <b>Error</b> lamp flashes.
	If the error message persists after several test sequences have been run, please contact your local Pfeiffer Vacuum service center.

EEPROM test

Test of the parameter memory.

	Test sequence
	The test runs automatically one time:
	⇒ Test in process (very briefly).
	⇒ Test finished, no error found.
	⇒ Test finished, error(s) found. The <b>Error</b> lamp flashes.
	If the error message persists after several test sequences have been run, please contact your local Pfeiffer Vacuum service center.

Display test

Test of the display.

	Test sequence
	The test runs automatically one time <sup>*)</sup> :
	⇒ First, all display elements are lit at the same time, ...
	⇒ ... and then, each element is lit individually.
<sup>*)</sup>	⇒ Stop the test sequence and activate one element after another by pressing the key once per element.

A/D converter test 0

Test of channel 0 of the analog/digital converter (with a reference voltage at the signal input of the *sensor* connector (→ 20)).



If the signal input is open, the TPG 262 displays a default value that may easily fluctuate because of the high sensitivity of the open measurement circuit.



Test sequence

⇒ Measuring signal CH1 in Volt.

A/D converter test 1

Test of channel 1 of the analog/digital converter (with a reference voltage at the signal input of the *sensor* connector (→ 20)).



If the signal input is open, the TPG 262 displays a default value that may easily fluctuate because of the high sensitivity of the open measurement circuit.



Test sequence

⇒ Measuring signal CH2 in Volt.



A/D converter test 2

Test of channel 2 of the analog/digital converter (with a reference voltage at the identification input of the *sensor* connector (→ 20)).



If the signal input is open, the TPG 262 displays a default value that may easily fluctuate because of the high sensitivity of the open measurement circuit.





	Test sequence
	
e.g.: 	⇒ Gauge identification voltage CH1
	⇒ No gauge connected

### A/D converter test 3

Test of channel 3 of the analog/digital converter (with a reference voltage at the identification input of the *sensor* connector (→  20)).



If the signal input is open, the TPG 262 displays a default value that may easily fluctuate because of the high sensitivity of the open measurement circuit.

	Test sequence
	
e.g.: 	⇒ Gauge identification voltage CH2
	⇒ No gauge connected

### I/O test















Test of the relays of the TPG 262. The program tests their switching function.

**Caution**

Caution: The relays switch irrespective of the pressure  
Starting a test program may cause unwanted effects in connected control systems.  
Disconnect all sensor cables and control system lines to ensure that no control commands or messages are triggered by mistake.

The relays switch on and off cyclically. The switching operations are indicated optically and can be heard.

The contacts of switching functions 1 ... 4 are connected to the *relay* connector (→ 22), the contacts of the error relay to the *control* connector (→ 21) on the rear of the housing. Check their function with an ohmmeter.

	Test sequence
	The test runs automatically one time:
	⇒ All relays deactivated
	⇒ Switching function relay 1
	
	⇒ Switching function relay 2
	
:	
	⇒ Switching function relay 4
	
	⇒ Gauge relay CH1
	
	⇒ Gauge relay CH2
	
	⇒ Error relay
	

RS232C test

Test of the RS232C interface. The TPG 262 repeats each sign transmitted by the communicating HOST.



The data transferred from/to the TPG 262 can be displayed by the computer only (→ 68).

	Test sequence
	The test runs automatically.

## 5 Communication (Serial Interface)

### 5.1 RS232C Interface

The serial interface is used for communication between the TPG 26x <sup>1)</sup> and a computer. A terminal can be connected for test purposes.

When the TPG 26x is put into operation, it starts transmitting measured values in intervals of 1 s. As soon as the first character is transferred to the TPG 26x, the automatic transmission of measured values stops. After the necessary inquiries or parameter modifications have been made, the transmission of measured values can be started again with the **COM** command (→  75).

Connection diagram  
connection cable

Pin assignment of the 9-pole D-Sub connector and RS232 interface cable →  23.

#### 5.1.1 Data Transmission

The data transmission is bi-directional, i.e. data and control commands can be transmitted in either direction.

Data format

1 start bit  
8 data bits  
No parity bit  
1 stop bit  
No hardware handshake

<sup>1)</sup> Communication structure and procedures are identical for both controllers TPG 261 and TPG 262. Therefore the term TPG 26x is used in this chapter.

## Definitions

The following abbreviations and symbols are used:

Symbol	Meaning	Dec.	Hex.
HOST	Computer or terminal		
[...]	Optional elements		
ASCII	American Standard Code for Information Interchange		
<ETX>	END OF TEXT (CTRL C) Reset the interface	3	03
<CR>	CARRIAGE RETURN Go to beginning of line	13	0D
<LF>	LINE FEED Advance by one line	10	0A
<ENQ>	ENQUIRY Request for data transmission	5	05
<ACK>	ACKNOWLEDGE Positive report signal	6	06
<NAK>	NEGATIVE ACKNOWLEDGE Negative report signal	21	15

"Transmit": Data transfer from HOST to TPG 26x  
 "Receive": Data transfer from TPG 26x to HOST

## Flow Control

After each ASCII string, the HOST must wait for a report signal (<ACK><CR><LF> or <NAK> <CR><LF>). The input buffer of the HOST must have a capacity of at least 32 bytes.

### 5.1.2 Communication Protocol

Transmission format

Messages are transmitted to the TPG 26x as ASCII strings in the form of mnemonic operating codes and parameters. All mnemonics comprise three ASCII characters.

Spaces are ignored. <ETX> (CTRL C) clears the input buffer in the TPG 26x.

Transmission protocol

HOST	TPG 26x	Explanation
Mnemonics [and parameters]	—————>	Receives message with "end of message"
<CR>[<LF>]	—————>	
<—————	<ACK><CR><LF>	Positive acknowledgment of a received message

Reception format

When requested with a mnemonic instruction, the TPG 26x transmits the measurement data or parameters as ASCII strings to the HOST.

<ENQ> must be transmitted to request the transmission of an ASCII string. Additional strings, according to the last selected mnemonic, are read out by repetitive transmission of <ENQ>.

If <ENQ> is received without a valid request, the ERROR word is transmitted.

Reception protocol

HOST	TPG 26x	Explanation
Mnemonics [and parameters] —————>		Receives message with "end of message"
<CR>[<LF>] —————>		
<————— <ACK><CR><LF>		Positive acknowledgment of a received message
<ENQ> —————>		Requests to transmit data
<————— Measurement values or parameters		Transmits data with "end of message"
<————— <CR><LF>		
	:	:
<ENQ> —————>		Requests to transmit data
<————— Measurement values or parameters		Transmits data with "end of message"
<————— <CR><LF>		

Error processing

The strings received are verified in the TPG 26x. If an error is detected, a negative acknowledgment <NAK> is output.

Error recognition protocol

HOST	TPG 26x	Explanation
Mnemonics [and parameters] —————>		Receives message with "end of message"
<CR>[<LF>] —————>		
***** Transmission or programming error *****		
<————— <NAK><CR><LF>		Negative acknowledgment of a received message
Mnemonics [and parameters] —————>		Receives message with "end of message"
<CR>[<LF>] —————>		
<————— <ACK><CR><LF>		Positive acknowledgment of a received message

## 5.2 Mnemonics

		→ 
<b>ADC</b>	A/D converter test	89
<b>BAU</b>	Baud rate (transmission rate)	85
<b>COM</b>	Continuous mode	75
<b>CAL</b>	Calibration factor	81
<b>DCD</b>	Display control digits (display resolution)	85
<b>DGS</b>	Degas	83
<b>DIC</b>	Display control (display changeover)	86
<b>DIS</b>	Display test	88
<b>EEP</b>	EEPROM test	88
<b>EPR</b>	EPROM test	88
<b>ERR</b>	Error status	77
<b>FIL</b>	Filter time constant (measurement value filter)	80
<b>FSR</b>	Full scale range (measurement range of linear gauges)	81
<b>IOT</b>	I/O test	90
<b>LOC</b>	Keylock	87
<b>OFC</b>	Offset correction (linear gauges)	82
<b>OFD</b>	Offset display (linear gauges)	82
<b>PNR</b>	Program number (firmware version)	86
<b>PR1</b>	Pressure measurement (measurement data) gauge 1	73
<b>PR2</b>	Pressure measurement (measurement data) gauge 2	73
<b>PRX</b>	Pressure measurement (measurement data) gauge 1 and 2	74
<b>PUC</b>	Penning underrange control (underrange control)	83
<b>RAM</b>	RAM test	88
<b>RES</b>	Reset	78
<b>RST</b>	RS232 test	91
<b>SAV</b>	Save parameters to EEPROM	86
<b>SC1</b>	Sensor control 1 (gauge control 1)	84
<b>SC2</b>	Sensor control 2 (gauge control 2)	84
<b>SCT</b>	Sensor channel change (measurement channel change)	77
<b>SEN</b>	Sensors on/off	76
<b>SP1</b>	Setpoint 1 (switching function 1)	79
<b>SP2</b>	Setpoint 2 (switching function 2)	79
<b>SP3</b>	Setpoint 3 (switching function 3)	79
<b>SP4</b>	Setpoint 4 (switching function 4)	79
<b>SPS</b>	Setpoint status (switching function status)	80
<b>TID</b>	Transmitter identification (gauge identification)	76
<b>TKB</b>	Keyboard test (operator key test)	91
<b>TLC</b>	Torr lock	87
<b>UNI</b>	Pressure unit	85
<b>WDT</b>	Watchdog control	87





Measurement data  
gauges 1 and 2

Transmit: PRX <CR>[<LF>]  
 Receive: <ACK><CR><LF>  
 Transmit: <ENQ>  
 Receive: x,sx.xxxxEsxx,y,sy.yyyyEsyy <CR><LF>

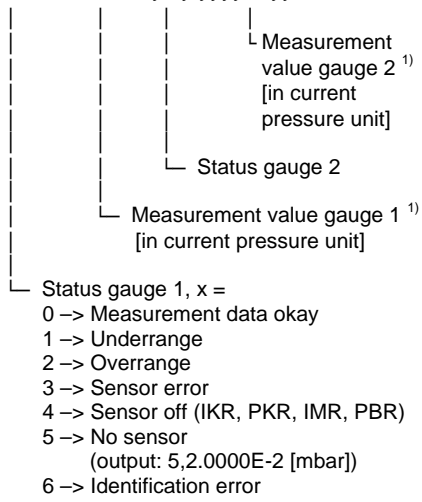

 <sup>1)</sup> Values always in exponential format.  
 For logarithmic gauges, the 3<sup>rd</sup> and 4<sup>th</sup> decimal are always 0.

Continuous output of measurement values (RS232)

Transmit: **COM** [,x] <CR>[<LF>]

└ Mode x = 0 → 100 ms  
1 → 1 s (default)  
2 → 1 min.

Receive: <ACK><CR><LF>

<ACK> is immediately followed by the continuous output of the measurement value in the desired interval.

Receive: x,sx.xxxxEsxx,y,sy.yyyyEsy <CR><LF>

└ Measurement value gauge 2 <sup>1)</sup>  
[in current pressure unit]

└ Status gauge 2

└ Measurement value gauge 1 <sup>1)</sup>  
[in current pressure unit]

└ Status gauge 1, x =  
0 → Measurement data okay  
1 → Underrange  
2 → Overrange  
3 → Sensor error  
4 → Sensor off (IKR, PKR, IMR, PBR)  
5 → No sensor  
(output: 5,2.0000E-2 [mbar])  
6 → Identification error



<sup>1)</sup> Values always in exponential format.

For logarithmic gauges, the 3<sup>rd</sup> and 4<sup>th</sup> decimal are always 0.



Measurement channel change

Transmit: **SCT** [,x] <CR><LF>  
 |  
 └─ Display channel, x =  
 0 → Gauge 1  
 1 → Gauge 2

Receive: <ACK><CR><LF>  
 Transmit: <ENQ>  
 Receive: x <CR><LF>  
 |  
 └─ Display channel

Error status

Transmit: **ERR** <CR><LF>  
 Receive: <ACK><CR><LF>  
 Transmit: <ENQ>  
 Receive: xxxx <CR><LF>  
 └─ xxxx =  
 0000 → No error  
 1000 → Error      Controller error  
    (See display  
    on front panel)  
 0100 → NO HWR      No hardware  
 0010 → PAR          Inadmissible  
    parameter  
 0001 → SYN          Syntax error



The ERROR word is cancelled when read out. If the error persists, it is immediately set again.

Reset

Transmit: **RES** [,x] <CR>[<LF>]

├  
└ x = 1 → Cancels currently active error and returns to measurement mode

Receive: <ACK><CR><LF>

Transmit: <ENQ>

Receive: [x]x,[x]x,... <CR><LF>

├  
└ List of all present error messages,  
xx =  
0 → No error  
1 → Watchdog has responded  
2 → Task fail error  
3 → EPROM error  
4 → RAM error  
5 → EEPROM error  
6 → DISPLAY error  
7 → A/D converter error  
9 → Gauge 1 error (e.g. filament rupture, no supply)  
10 → Gauge 1 identification error  
11 → Gauge 2 error (e.g. filament rupture, no supply)  
12 → Gauge 2 identification error

## 5.2.2 Parameter Mode

### 5.2.2.1 Switching Function Parameters

Threshold value setting, allocation

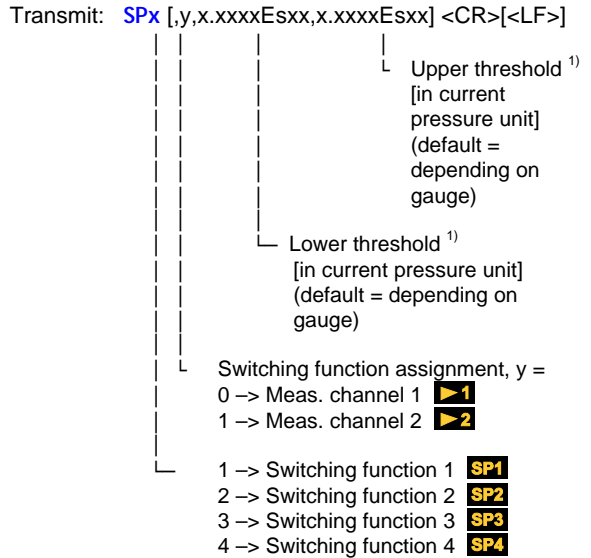

<sup>1)</sup> Values can be entered in any format. They are internally converted into the floating point format.

Receive: <ACK><CR><LF>

Transmit: <ENQ>

Receive: y,x.xxxxEsxx,x.xxxxEsxx <CR><LF>

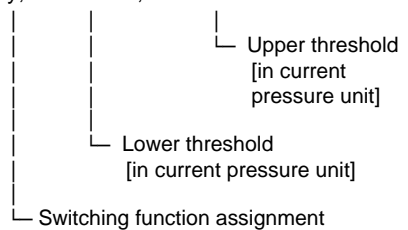

Switching function  
status

Transmit: **SPS** <CR>[<LF>]  
 Receive: <ACK><CR><LF>  
 Transmit: <ENQ>  
 Receive: x,x,x,x <CR><LF>

| | | |  
 | | | |└─ Status switching function 4 **SP4** <sup>1)</sup>  
 | | | └─ Status switching function 3 **SP3** <sup>1)</sup>  
 | | └─ Status switching function 2 **SP2** <sup>1)</sup>  
 | └─ Status switching function 1 **SP1** <sup>1)</sup>

<sup>1)</sup> x = 0 → off  
 1 → on

5.2.2.2 Gauge Parameters

Measurement value  
filter

Transmit: **FIL** [,x,x] <CR>[<LF>]

| | |  
 | | └─ Gauge 2 x = 0 → fast  
 | | 1 → medium  
 | | (default)  
 | | 2 → slow  
 | └─ Gauge 1

Receive: <ACK><CR><LF>  
 Transmit: <ENQ>  
 Receive: x,x <CR><LF>

| |  
 | └─ Filter time constant gauge 2  
 |  
 | └─ Filter time constant gauge 1



Calibration factor

Transmit: **CAL** [,x.xxx,x.xxx] <CR><LF> ( **CAL** )

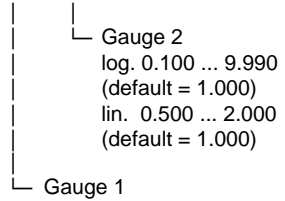

Receive: <ACK><CR><LF>

Transmit: <ENQ>

Receive: x.xxx,x.xxx <CR><LF>

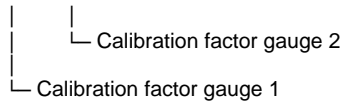

Measurement range (F.S.) of linear gauges



The full scale value of the measurement range (Full Scale) of linear gauges has to be defined by the user; the full scale value of logarithmic gauges is automatically recognized.

Transmit: **FSR** [,x,x] <CR><LF>

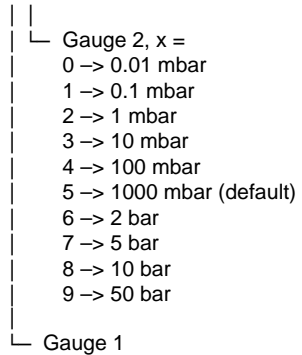

Receive: <ACK><CR><LF>

Transmit: <ENQ>

Receive: x,x <CR><LF>

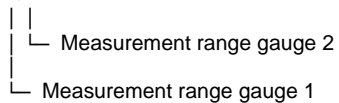





5.2.2.3 Gauge Control

Gauge control

Transmit: **SCx** [,x,y,x.xxEsxx,y.yyEsyy] <CR>[<LF>]

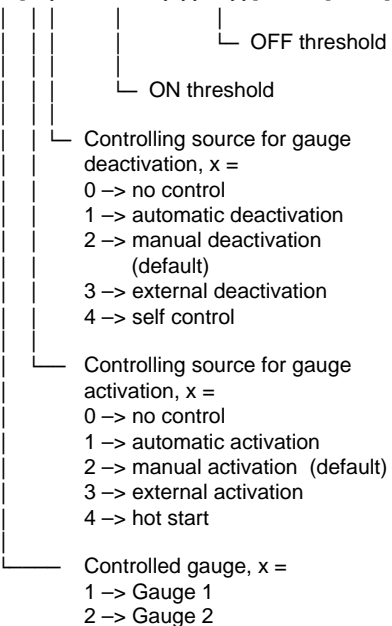

Receive: <ACK><CR><LF>

Transmit: <ENQ>

Receive: x,y,x.xxEsxx,y.yyEsyy <CR><LF>

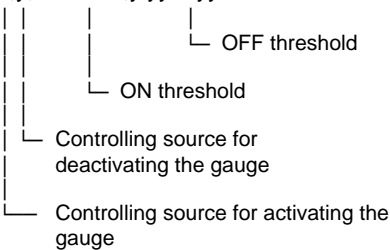

### 5.2.2.4 General Parameters

Pressure unit

Transmit: **UNI** [,x] <CR>[<LF>]  
 |  
 └─ Pressure unit, x =  
 0 → mbar/bar (default)  
 1 → Torr  
 2 → Pascal

Receive: <ACK><CR><LF>

Transmit: <ENQ>

Receive: x <CR><LF>

|  
 └─ Pressure unit

Transmission rate

Transmit: **BAU** [,x] <CR>[<LF>]  
 |  
 └─ Transmission rate, x =  
 0 → 9600 baud (default)  
 1 → 19200 baud  
 2 → 38400 baud



As soon as the new baud rate has been entered, the report signal is transmitted at the new transmission rate.

Receive: <ACK><CR><LF>

Transmit: <ENQ>

Receive: x <CR><LF>

|  
 └─ Transmission rate

Display resolution

Transmit: **DCD** [,x] <CR>[<LF>]  
 |  
 └─ Resolution, x =  
 2 → Display x.x (2 digits)  
 (default)  
 3 → Display x.xx (3 digits)

Receive: <ACK><CR><LF>

Transmit: <ENQ>

Receive: x <CR><LF>

|  
 └─ Resolution

Save parameters to EEPROM      Transmit:      **SAV** [,x] <CR>[<LF>]

└─ x = 0 -> Save default parameters  
           1 -> Save user parameters

Receive:      <ACK><CR><LF>

Display changeover      Transmit:      **DIC** [,x] <CR>[<LF>]

└─ Measurement display behavior when a Pirani gauge or a Pirani Capacitance gauge is combined with a linear gauge with 1000 mbar F.S., x =  
           0 -> manual (default)  
           1 -> automatic

Receive:      <ACK><CR><LF>

Transmit:      <ENQ>

Receive:      x <CR><LF>

└─ Measurement display behavior

**5.2.2.5 Test Parameters**      (For service personnel)

Firmware version      Transmit:      **PNR** <CR>[<LF>]

Receive:      <ACK><CR><LF>

Transmit:      <ENQ>

Receive:      302-510-x <CR><LF>

└─ -x = Modification index ( -- = original version)

└─ Firmware number

Watchdog control

Transmit: **WDT** [,x] <CR>[<LF>]

└ x = 0 → Manual error acknowledgement  
 1 → Automatic error acknowledgement <sup>1)</sup> (default)



<sup>1)</sup> If the watchdog has responded, the error is automatically acknowledged and cancelled after 2 s.

Receive: <ACK><CR><LF>

Transmit: <ENQ>

Receive: x <CR><LF>

└ Watchdog control

Torr lock

Transmit: **TLC** [,x] <CR>[<LF>]

└ x = 0 → off (default)  
 1 → on

Receive: <ACK><CR><LF>

Transmit: <ENQ>

Receive: x <CR><LF>

└ Torr lock status

Keylock

Transmit: **LOC** [,x] <CR>[<LF>]

└ x = 0 → off (default)  
 1 → on

Receive: <ACK><CR><LF>

Transmit: <ENQ>

Receive: x <CR><LF>

└ Keylock status

RAM test

Transmit: **RAM** <CR>[<LF>]  
 Receive: <ACK><CR><LF>  
 Transmit: <ENQ> Starts the test (duration <1 s)  
 Receive: xxxx <CR><LF>  
           |  
           └─ ERROR word

EPROM test

Transmit: **EPR** <CR>[<LF>]  
 Receive: <ACK><CR><LF>  
 Transmit: <ENQ> Starts the test (duration ≈5 s)  
 Receive: xxxx,yyyy <CR><LF>  
           |          |  
           |          └─ Check sum (hex)  
           └─ ERROR word

EEPROM test

Transmit: **EEP** <CR>[<LF>]  
 Receive: <ACK><CR><LF>  
 Transmit: <ENQ> Starts the test (duration <1 s)



Do not keep repeating the test (EEPROM life).

Receive: xxxx <CR><LF>  
           |  
           └─ ERROR word

Display test

Transmit: **DIS** [,x] <CR>[<LF>]  
           |  
           └─ x = 0 → Stops the test – display according to current operating mode (default)  
                   1 → Starts the test – all LEDs on

Receive: <ACK><CR><LF>  
 Transmit: <ENQ>  
 Receive: x <CR><LF>  
           |  
           └─ Display test status



ADC test

Transmit: **ADC** <CR>[<LF>]

Receive: <ACK><CR><LF>

Transmit: <ENQ>

Receive: [x]x.xxxx,[x]x.xxxx,x.xxxx,x.xxxx <CR><LF>

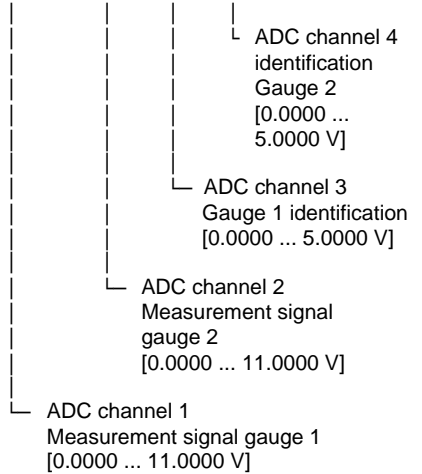

I/O test

**Caution**

Caution: The relays switch irrespective of the pressure.  
 Starting a test program may cause unwanted effects in connected control systems.  
 Disconnect all sensor cables and control system lines to ensure that no control commands or messages are triggered by mistake.

Transmit: **IOT** [,x,yy] <CR>[<LF>]

- ├ Relay status (in hex format), yy =
- 00 → All relays deactivated
- 01 → Switching function relay 1 activated
- 02 → Switching function relay 2 activated
- 04 → Switching function relay 3 activated
- 08 → Switching function relay 4 activated
- 10 → Gauge relay CH1 activated
- 20 → Gauge relay CH2 activated
- 40 → Error relay activated
- 7F → All relays activated
- ├ x = 0 → Test stopped
- 1 → Test runs

Receive: <ACK><CR><LF>

Transmit: <ENQ>

Receive: x,yy <CR><LF>

- ├ Relay status
- ├ I/O test status

Operator key test

Transmit: **TKB** <CR>[<LF>]  
 Receive: <ACK><CR><LF>  
 Transmit: <ENQ>  
 Receive: xxxx <CR><LF>

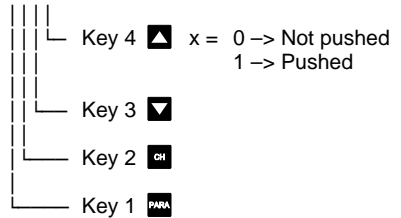

RS232 test

Transmit: **RST** <CR>[<LF>]  
 Receive: <ACK><CR><LF>  
 Transmit: <ENQ> Starts the test (repeats each character, test is interrupted with <CTRL> C)

### 5.2.3 Example



"Transmit (T)" and "Receive (R)" are related to Host.

S: <b>TID</b> <CR> [<LF>]	Request for gauge identification
E: <ACK> <CR> <LF>	Positive acknowledgement
S: <ENQ>	Request for data transmission
E: TPR,CMR <CR> <LF>	Gauge identifications
S: <b>SEN</b> <CR> [<LF>]	Request for gauge statuses
E: <ACK> <CR> <LF>	Positive acknowledgement
S: <ENQ>	Request for data transmission
E: 0,0 <CR> <LF>	Gauge statuses
S: <b>SP1</b> <CR> [<LF>]	Request for parameters of switching function 1 (setpoint 1)
E: <ACK> <CR> <LF>	Positive acknowledgement
S: <ENQ>	Request for data transmission
E: 0,1.0000E-09,9.0000E-07 <CR> <LF>	Thresholds
S: <b>SP1</b> ,1,6.80E-3,9.80E-3 <CR> [<LF>]	Modification of parameters of switching function 1 (setpoint 1)
E: <ACK> <CR> <LF>	Positive acknowledgement
S: <b>FOL</b> ,1,2 <CR> [<LF>]	Modification of filter time constant (syntax error)
E: <NAK> <CR> <LF>	Negative acknowledgement
S: <ENQ>	Request for data transmission
E: 0001 <CR> <LF>	ERROR word
S: <b>FIL</b> ,1,2 <CR> [<LF>]	Modification of filter time constant
E: <ACK> <CR> <LF>	Positive acknowledgement
S: <ENQ>	Request for data transmission
E: 1,2 <CR> <LF>	Filter time constants

## 6 Maintenance

The product requires no maintenance.

### Cleaning the TPG 262

For cleaning the outside of the TPG 262, a slightly moist cloth will usually do. Do not use any aggressive or scouring cleaning agents.

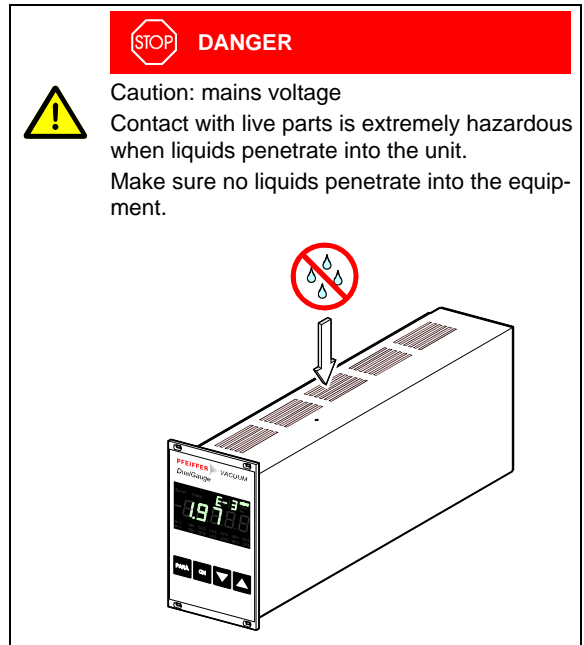

## 7 Troubleshooting

Signalization of errors



and the error relay opens (→  21).

Error messages

**SE** 

Possible cause and remedy/  
acknowledgement



Interruption or instability in sensor line  
or connector (Sensor error).

⇒ Acknowledge with the  key.  
If the problem persists, **noSEN** or  
**noPD** is displayed.



**DE** 

Possible cause and remedy/  
acknowledgement

The TPG 262 has been turned on too  
fast after power off.

⇒ Acknowledge with the  key.  
If the watchdog is set to **Auto**,  
the TPG 262 acknowledges the  
message automatically after 2 s  
(→  61).

The watchdog has tripped because of  
a severe electric disturbance or an op-  
erating system error.

⇒ Acknowledge with the  key.  
If the watchdog is set to **Auto**,  
the TPG 262 acknowledges the  
message automatically after 2 s  
(→  61).

**RA** 

Possible cause and remedy/  
acknowledgement

Main memory (RAM) error.









⇒ Acknowledge with the  key.

**EP** 

Possible cause and remedy/  
acknowledgement

Program memory (EPROM) error.

⇒ Acknowledge with the  key.

	Possible cause and remedy/ acknowledgement
	Parameter memory (EEPROM) error. ⇒ Acknowledge with the  key.
	Possible cause and remedy/ acknowledgement
	Display driver error. ⇒ Acknowledge with the  key.
	Possible cause and remedy/ acknowledgement
	A/D converter error. ⇒ Acknowledge with the  key.
	Possible cause and remedy/ acknowledgement
	Operating system (Task Fail) error. ⇒ Acknowledge with the  key.

### Technical support



If the problem persists after the message has been acknowledged for several times and/or the gauge has been exchanged, please contact your local Pfeiffer Vacuum service center.

## 8 Repair

Return defective products to your nearest Pfeiffer Vacuum service center for repair.

Pfeiffer Vacuum assumes no liability and the warranty becomes null and void if repair work is carried out by the end-user or third parties.

## 9 Storage



### Caution



Caution: electronic component

Inappropriate storage (static electricity, humidity etc.) can damage electronic components.

Store the product in an antistatic bag or container. Observe the corresponding specifications in the technical data (→ 9).

## 10 Disposal



### WARNING



Caution: substances detrimental to the environment

Products or parts thereof (mechanical and electric components, operating fluids etc.) can be detrimental to the environment.

Dispose of such substances in accordance with the relevant local regulations.

Separating the components

Non-electronic components

Electronic components

After disassembling the product, separate its components according to the following criteria:

Such components must be separated according to their materials and recycled.

Such components must be separated according to their materials and recycled.



## Appendix

### A: Conversion Tables

#### Weights

	<b>kg</b>	<b>lb</b>	<b>slug</b>	<b>oz</b>
<b>kg</b>	1	2.205	$68.522 \times 10^{-3}$	35.274
<b>lb</b>	0.454	1	$31.081 \times 10^{-3}$	16
<b>slug</b>	14.594	32.174	1	514.785
<b>oz</b>	$28.349 \times 10^{-3}$	$62.5 \times 10^{-3}$	$1.943 \times 10^{-3}$	1

#### Pressures

	<b>N/m<sup>2</sup>, Pa</b>	<b>bar</b>	<b>mbar</b>	<b>Torr</b>	<b>at</b>
<b>N/m<sup>2</sup>, Pa</b>	1	$10 \times 10^{-6}$	$10 \times 10^{-3}$	$7.5 \times 10^{-3}$	$9.869 \times 10^{-6}$
<b>bar</b>	$100 \times 10^3$	1	$10^3$	750.062	0.987
<b>mbar</b>	100	$10^{-3}$	1	$750.062 \times 10^{-3}$	$0.987 \times 10^{-3}$
<b>Torr</b>	133.322	$1.333 \times 10^{-3}$	1.333	1	$1.316 \times 10^{-3}$
<b>at</b>	$101.325 \times 10^3$	1.013	$1.013 \times 10^3$	760	1

#### Pressure units used in the vacuum technology

	<b>mbar</b>	<b>Pascal</b>	<b>Torr</b>	<b>mmWs</b>	<b>psi</b>
<b>mbar</b>	1	100	$750.062 \times 10^{-3}$	10.2	$14.504 \times 10^{-3}$
<b>Pascal</b>	$10 \times 10^{-3}$	1	$7.5 \times 10^{-3}$	0.102	$0.145 \times 10^{-3}$
<b>Torr</b>	1.333	133.322	1	13.595	$19.337 \times 10^{-3}$
<b>mmWs</b>	$9.81 \times 10^{-2}$	9.81	$7.356 \times 10^{-2}$	1	$1.422 \times 10^{-3}$
<b>psi</b>	68.948	$6.895 \times 10^3$	51.715	703	1

#### Linear measures















	<b>mm</b>	<b>m</b>	<b>inch</b>	<b>ft</b>
<b>mm</b>	1	$10^{-3}$	$39.37 \times 10^{-3}$	$3.281 \times 10^{-3}$
<b>m</b>	$10^3$	1	39.37	3.281
<b>inch</b>	25.4	$25.4 \times 10^{-3}$	1	$8.333 \times 10^{-2}$
<b>ft</b>	304.8	0.305	12	1

#### Temperature

	<b>Kelvin</b>	<b>Celsius</b>	<b>Fahrenheit</b>
<b>Kelvin</b>	1	$^{\circ}\text{C} + 273.15$	$(^{\circ}\text{F} + 459.67) \times 5/9$
<b>Celsius</b>	$\text{K} - 273.15$	1	$5/9 \times ^{\circ}\text{F} - 17.778$
<b>Fahrenheit</b>	$9/5 \times \text{K} - 459.67$	$9/5 \times (^{\circ}\text{C} + 17.778)$	1

## B: Default Parameter Settings

The following values are activated when the default parameter settings are loaded (→  57):

	Default	User	
	1×10 <sup>-11</sup> mbar		
	9×10 <sup>-11</sup> mbar		
	normal		
	1.00 (log) 1.000 (lin)		
	1000 mbar		
	off 0×10 <sup>-2</sup> mbar		
	off		
	mbar		
	9600		
	2 Digit		
	Hand		
	Auto		
	off		
	off		

## C: Firmware Update



If your TPG 262 firmware needs updating, e.g. for implementing a new gauge type, please contact your local Pfeiffer Vacuum service center.

### User parameters

Most of the settings you may have defined in the Parameter and Test mode will not be affected by a firmware update. To be sure, note your parameter settings before upgrading the firmware (→ 98).

### Preparing the TPG 262 for a program transfer

- 1 Turn the TPG 262 off.
- 2 Connect the TPG 262 with the serial COM1 (COM2) interface of your PC via a 9-pole D-Sub extension cable (→ 23) (the firmware of the TPG 262 cannot be loaded from a Mac).
- 3 With a pin ( $\varnothing < 2$  mm) depress the switch on the top of the unit, under the housing, and turn the TPG 262 on.

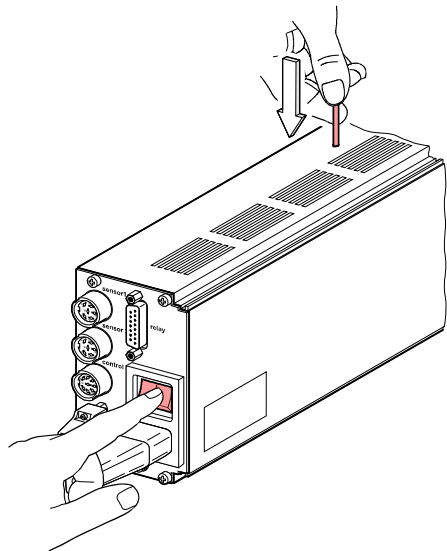

After power on, the display remains dark.

Program transfer

In the following instructions, the index -n is used instead of the actual index.

- 1 **1** Unpack the self extracting file  
SingleDualGauge 302-510-n.exe.

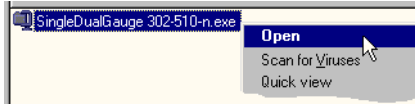

- 2 **2** If you have not connected the TPG 262 to the COM1 interface:

- Open the batch file Update 302-510-n.bat ...

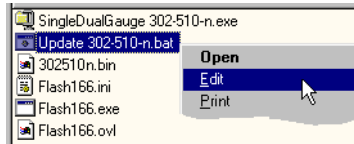

- ... edit the interface ...



- ... and save the new setting.

- 3 **3** Start batch file Update 302-510-n.bat .

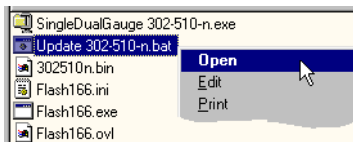

⇒ The new firmware is transmitted to the TPG 262.

```

Benedol - Update 302510n
D:\TPG26X\5\Update>FLASH166 /P 302510n.BIN /COM1 /DEVICE=PSD833F2
FLASH166 --- Utility for 80C166, C16x and ST10 using bootstrap
Copyright (C) FS FORTH-SYSTEME GmbH, Breisach
Version 3.03 of 06/14/2000, Limited OEM Version (21279)

Restarting target monitor
Target monitor located to 00FA40H
Infineon C161PI
CPU clock = 24.098.133 MHz
Configuration loaded from file FLASH166.INI
Target: SINGLE-/DUALGAUGE, PFEIFFER VACUUM

wSI PSD833F2 detected
Loading flash algorithm (138 Bytes)
Erasing Flash-EPROM Block #:0 1 2 3 4 5 6 7
Programming File 302510n.BIN (131072 Bytes)
131072 Bytes programmed
programming ok

Erase Time      : 3.7 sec
Programming Time: 36.5 sec
    
```

Starting the TPG 262 with the updated firmware

If the program transfer was successful, quit the Update mode by turning the TPG 262 off.

















Wait at least 10 s before turning the TPG 262 on again in order for it to correctly initialize itself.



The TPG 262 is now ready for operation. To be sure, check that the current parameter settings are identical with the previously defined settings (→ [98](#)).

## D: Literature

-  [1] [www.pfeiffer-vacuum.de](http://www.pfeiffer-vacuum.de)  
 Instruction Sheet  
 Compact Pirani Gauge TPR 261  
 BG 805 105 BE  
 Pfeiffer Vacuum GmbH, D-35614 Asslar,  
 Deutschland
-  [2] [www.pfeiffer-vacuum.de](http://www.pfeiffer-vacuum.de)  
 Operating Instructions  
 Compact Pirani Gauge TPR 265  
 BG 805 177 BE  
 Pfeiffer Vacuum GmbH, D-35614 Asslar,  
 Deutschland
-  [3] [www.pfeiffer-vacuum.de](http://www.pfeiffer-vacuum.de)  
 Operating Instructions  
 Pirani-Messröhre TPR 280  
 BG 805 178 BE  
 Pfeiffer Vacuum GmbH, D-35614 Asslar,  
 Deutschland
-  [4] [www.pfeiffer-vacuum.de](http://www.pfeiffer-vacuum.de)  
 Operating Instructions  
 Pirani-Messröhre TPR 281  
 BG 5179 BE  
 Pfeiffer Vacuum GmbH, D-35614 Asslar,  
 Deutschland
-  [5] [www.pfeiffer-vacuum.de](http://www.pfeiffer-vacuum.de)  
 Operating Instructions  
 Compact Pirani Capacitance Gauge PCR 260  
 BG 805 180 BE  
 Pfeiffer Vacuum GmbH, D-35614 Asslar,  
 Deutschland
-  [6] [www.pfeiffer-vacuum.de](http://www.pfeiffer-vacuum.de)  
 Instruction Sheet  
 Compact Cold Cathode Gauge IKR 251  
 BG 805 110 BN  
 Pfeiffer Vacuum GmbH, D-35614 Asslar,  
 Deutschland
-  [7] [www.pfeiffer-vacuum.de](http://www.pfeiffer-vacuum.de)  
 Instruction Sheet  
 Compact Cold Cathode Gauge IKR 261  
 BG 805 113 BN  
 Pfeiffer Vacuum GmbH, D-35614 Asslar,  
 Deutschland

-  [8] [www.pfeiffer-vacuum.de](http://www.pfeiffer-vacuum.de)  
 Instruction Sheet  
 Compact Cold Cathode Gauge IKR 270  
 BG 805 115 BE / A  
 Pfeiffer Vacuum GmbH, D-35614 Aslar,  
 Deutschland
-  [9] [www.pfeiffer-vacuum.de](http://www.pfeiffer-vacuum.de)  
 Instruction Sheet  
 Compact FullRange™ Gauge PKR 251  
 BG 805 119 BN  
 Pfeiffer Vacuum GmbH, D-35614 Aslar,  
 Deutschland
-  [10] [www.pfeiffer-vacuum.de](http://www.pfeiffer-vacuum.de)  
 Instruction Sheet  
 Compact FullRange™ Gauge PKR 261  
 BG 805 122 BN  
 Pfeiffer Vacuum GmbH, D-35614 Aslar,  
 Deutschland
-  [11] [www.pfeiffer-vacuum.de](http://www.pfeiffer-vacuum.de)  
 Instruction Sheet  
 Compact Process Ion Gauge IMR 265  
 BG 805 132 BE  
 Pfeiffer Vacuum GmbH, D-35614 Aslar,  
 Deutschland
-  [12] [www.pfeiffer-vacuum.de](http://www.pfeiffer-vacuum.de)  
 Instruction Sheet  
 Compact FullRange™ BA Gauge PBR 260  
 BG 805 131 BE  
 Pfeiffer Vacuum GmbH, D-35614 Aslar,  
 Deutschland
-  [13] [www.pfeiffer-vacuum.de](http://www.pfeiffer-vacuum.de)  
 Instruction Sheet  
 Compact Capacitance Gauge  
 CMR 261 ... CMR275  
 BG 805 133 BE  
 Pfeiffer Vacuum GmbH, D-35614 Aslar,  
 Deutschland
-  [14] [www.pfeiffer-vacuum.de](http://www.pfeiffer-vacuum.de)  
 Instruction Sheet  
 Compact Piezo Gauge APR 250 ... APR 267  
 BG 805 127 BN  
 Pfeiffer Vacuum GmbH, D-35614 Aslar,  
 Deutschland

## E: Index

<b>– A –</b>		<b>– G –</b>	
A/D converter test	64	Gauge connector	20
		Gauge control	12; 47
<b>– B –</b>		gauge activation	49
Baud rate	56	gauge deactivation	51
		OFF threshold	52
<b>– C –</b>		ON threshold	50
Calibration factor	41	Gauge identification	30
Cleaning	93	Gauge parameters	38
Communication	68	calibration factor	41
interface	68	measurement value filter	39
Connectors		General parameters	54
<i>control</i>	21	default values	57
mains power	19	display changeover	57
<i>relay</i>	22	display resolution	56
<i>RS232</i>	23	measurement unit	56
<i>sensor</i>	20	transmission rate	56
Contact positions		<b>– I –</b>	
<i>control</i>	21	I/O test	65
<i>relay</i>	22	Identification of gauges	30
Contents	4	Intended use	3
<i>control</i> connector	21	Interface	
Conversion	97	connector	23
		test	67
<b>– D –</b>		<b>– K –</b>	
Default values	57; 98	Keylock	61
Degas	46		
Display		<b>– L –</b>	
changeover	57	Liability	8
resolution	56	Literature	102
test	63		
Disposal	96	<b>– M –</b>	
		Mains power connector	19
<b>– E –</b>		Maintenance	93
EEPROM test	63	Measurement mode	27; 73
EPROM test	62	gauge identification	30
Error messages	94	selecting a measurement	
Example	92	channel	28
		status messages	28
<b>– F –</b>		turning a gauge on and off	28
Factory settings	57; 98	Measurement range	42
Filter	39	Measurement units	
Firmware		conversion	97
update	99	selection	56
version	2; 60	Measurement value filter	39
		Mnemonics	72



**– O –**

OFF threshold	52
Offset	43
ON threshold	50
Operating modes	
Measurement mode	27
overview	26
Parameter mode	31
Program transfer mode	99
Operation	
power off	25
power on	25

**– P –**

Parameter mode	79
gauge control	47
gauge parameters	38
general parameters	54
measurement value filter	39
switching function	
parameters	33
switching thresholds	35; 36
test parameters	58
Parameters	
Degas	46
measurement range	42
Offset	43
underrange control	44
Pin assignment	
<i>control</i>	21
<i>relay</i>	22
<i>RS232</i>	23
<i>sensor</i>	20
Power connector	19
Power off	25
Power on	25
Pressure units	
conversion	97
selection	56
Program	
update	99
version	2; 60

**– R –**

RAM test	62
<i>relay</i> connector	22
Repair	95
<i>RS232</i> connector	23
RS232C test	67

**– S –**

Safety	6
Scope of delivery	3
<i>sensor</i> connector	20
Serial interface	
connector	23
test	67
Status messages	28
Storage	96
Switching function	
parameters	33
Switching functions	11; 22
thresholds	35; 36
Symbols	6

**– T –**

Test parameters	58
Test program	58
A/D converter test	64
display test	63
EEPROM test	63
EPROM test	62
firmware version	60
I/O test	65
keylock	61
RAM test	62
RS232C test	67
Torr lock	61
watchdog	61
Thresholds	35; 36
OFF	52
ON	50
Torr lock	61
Transmission rate	56
Troubleshooting	94

**– U –**

Underrange control	44
Units	
conversion	97
selection	56
Update	99

**– V –**

Validity	2
----------	---

**– W –**

Warranty	8
Watchdog	61

## Declaration of Conformity



We, Pfeiffer Vacuum, hereby declare that the equipment mentioned below complies with the provisions of the Directive relating to electrical equipment designed for use within certain voltage limits 73/23/EEC and the Directive relating to electromagnetic compatibility 89/336/EEC.

Product

**DualGauge™**

Dual-Channel Measurement and Control Unit for Compact Gauges

TPG 262

Part number

PTG28280

Standards

Harmonized and international/national standards and specifications:

- EN 61010-1 (Safety requirements for electrical equipment for measurement, control and laboratory use)
- EN 50081-1 (Electromagnetic compatibility generic emission standard)
- EN 50082-2 (Electromagnetic compatibility generic immunity standard)

Signature

Pfeiffer Vacuum GmbH, Asslar

19 April 2001

Wolfgang Dondorf  
Managing director

## Notes

**PFEIFFER**  **VACUUM**

*Berliner Strasse 43  
D-35614 Asslar  
Deutschland  
Tel +49 (0) 6441 802-0  
Fax +49 (0) 6441 802-202  
info@pfeiffer-vacuum.de*

*Original: German BG 805 196 BD / B (2004-08)*



bg805196be/ b

*www.pfeiffer-vacuum.de*