



**Series AVME9630/9660 Industrial I/O Pack
VMEbus 3U/6U Non-Intelligent Carrier Boards**

USER'S MANUAL

ACROMAG INCORPORATED

30765 South Wixom Road

P.O. BOX 437

Wixom, MI 48393-7037 U.S.A.

Tel: (248) 624-1541

Fax: (248) 624-9234

Copyright 1994, Acromag, Inc., Printed in the USA.
Data and specifications are subject to change without notice.

8500-482-G01B003

The information contained in this manual is subject to change without notice. Acromag, Inc. makes no warranty of any kind with regard to this material, including, but not limited to, the implied warranties of merchantability and fitness for a particular purpose. Further, Acromag, Inc. assumes no responsibility for any errors that may appear in this manual and makes no commitment to update, or keep current, the information contained in this manual. No part of this manual may be copied or reproduced in any form, without the prior written consent of Acromag, Inc.

Table of Contents	Page
1.0 GENERAL INFORMATION	2
KEY AVME9630/9660 FEATURES.....	2
VMEbus INTERFACE FEATURES.....	3
SIGNAL INTERFACE PRODUCTS.....	3
INDUSTRIAL I/O PACK SOFTWARE LIBRARY.....	3
2.0 PREPARATION FOR USE	4
UNPACKING AND INSPECTION.....	4
CARD CAGE CONSIDERATIONS.....	4
BOARD CONFIGURATION.....	4
VMEbus INTERFACE CONFIGURATION.....	4
Address Decode Jumper Configuration.....	4
VMEbus Address Modifiers.....	4
Interrupt Configuration.....	5
CONNECTORS.....	5
Carrier Field I/O Connectors (IP modules A-D).....	5
IP Field I/O Connectors (IP modules A-D).....	5
IP Logic Interface Connectors (IP modules A-D).....	5
VMEbus Connections.....	5
POWER-UP TIMING AND LOADING.....	6
DATA TRANSFER TIMING.....	6
FIELD GROUNDING CONSIDERATIONS.....	6
3.0 PROGRAMMING INFORMATION	6
MEMORY MAPS.....	6
Identification PROM.....	8
Carrier Board Status Register.....	8
Interrupt Level Register.....	8
IP Error Register.....	9
IP Memory Enable Register.....	9
IP Memory Base Address & Size Registers.....	9
IP Interrupt Enable Register.....	10
IP Interrupt Pending Register.....	10
IP Interrupt Clear Register.....	10
GENERAL PROGRAMMING CONSIDERATIONS.....	10
Board Diagnostics.....	10
GENERATING INTERRUPTS.....	11
Interrupt Configuration Example.....	11
Sequence of Events for an Interrupt.....	11
4.0 THEORY OF OPERATION	11
CARRIER BOARD OVERVIEW.....	11
VMEbus Interface.....	11
Carrier Board Registers.....	12
IP Logic Interface.....	12
Carrier Board Clock Circuitry.....	12
IP Read and Write Cycle Timing.....	12
VME Interrupter.....	12
Power Failure Monitor.....	13
Assess LEDs and Pulse Stretcher Circuitry.....	13
Power Supply Filters.....	13

5.0 SERVICE AND REPAIR	13
SERVICE AND REPAIR ASSISTANCE.....	13
PRELIMINARY SERVICE PROCEDURE.....	13
6.0 SPECIFICATIONS	13
GENERAL SPECIFICATIONS.....	13
VMEbus COMPLIANCE.....	14
INDUSTRIAL I/O PACK COMPLIANCE.....	14
APPENDIX	15
CABLE: MODEL 5025-550.....	15
CABLE: MODEL 5025-551.....	15
TERMINATION PANEL: MODEL 5025-552.....	15
TRANSITION MODULE: MODEL TRANS-GP.....	15
DRAWINGS	Page
4501-450 AVME9630/9660 JUMPER & IP LOCATIONS.....	16
4501-434 MECHANICAL ASSEMBLY DRAWING.....	16
4501-451 AVME9630/9660 BLOCK DIAGRAM.....	17
4501-462 CABLE 5025-550 (NON-SHIELDED).....	17
4501-463 CABLE 5025-551 (SHIELDED).....	18
4501-464 TERMINATION PANEL 5025-552.....	18
4501-465 TRANSITION MODULE TRANS-GP.....	19

IMPORTANT SAFETY CONSIDERATIONS

It is very important for the user to consider the possible adverse effects of power, wiring, component, sensor, or software failures in designing any type of control or monitoring system. This is especially important where economic property loss or human life is involved. It is important that the user employ satisfactory overall system design. It is agreed between the Buyer and Acromag, that this is the Buyer's responsibility.

1.0 GENERAL INFORMATION

The AVME9630/9660 Series of VMEbus cards are carriers for the Industrial I/O Pack (IP) mezzanine board field I/O modules. The carrier boards facilitate a modular approach to system assembly, since each carrier can be populated with any combination of analog input/output and digital input/output IP modules. Thus, the user can create a board which is customized to the application which saves money and space - a single carrier board populated with IP modules may replace several dedicated function VMEbus boards. The AVME9630/9660 non-intelligent carrier boards provide impressive functionality at low cost.

Models are available in two standard VMEbus sizes, 3U and 6U, with support for up to two and four IP modules, respectively.

MODEL	VMEbus Board Size	Supported IP Slots	Operating Temperature Range
AVME9630	3U	2 (A & B)	0 to +70 °C
AVME9660	6U	4 (A,B,C,D)	0 to +70 °C
AVME9630E	3U	2 (A & B)	-40 to +85°C
AVME9660E	6U	4 (A,B,C,D)	-40 to +85°C

KEY AVME9630/9660 FEATURES

- **Interface for Two or Four IP Modules** - Provides an electrical and mechanical interface for up to four industry standard IP modules. IP Modules are available from Acromag and other vendors in a wide variety of Input/Output configurations to meet the needs of varied applications.
- **Provides Full IP Data Access** - Supports accesses to IP input/output, memory, and ID PROM data spaces.
- **Full IP Register Access** - Makes maximum use of logically organized programmable registers on the carrier boards to provide for easy configuration and control of IP modules. The only hardware jumper settings required on the carrier boards set the base address of the card in the VMEbus short I/O space.
- **LED Displays Simplify Debugging** - Front panel LED's are dedicated to each IP module to give a visual indication of successful IP accesses.
- **Front Panel Connectors Access I/O** - Front panel access to field I/O signals is provided via industry standard 50-pin headers. A separate header is provided for each IP module. All headers can be connected to flat ribbon cable from the front panel without interference from boards in adjacent slots. Ejector latches on the headers provide for excellent connection integrity and easy cable removal.
- **Optional Screw Termination Panel** - Model supports field connection via screw terminals using the optional DIN rail mount termination panels.
- **Memory Space Access Support** - IP memory space accesses are supported and software configurable from 1Mbyte to 8Mbytes in the VMEbus standard address space.
- **Supports Two Interrupt Channels per IP** - Up to two interrupt requests are supported for each IP. The VMEbus interrupt level is software programmable. Additional registers are associated with each interrupt request for control and status monitoring.
- **Supervisory Circuit for Reset Generation** - A microprocessor supervisor circuit provides power-on, power-off, and low power detection reset signals to the IP modules per the IP specification.
- **Individually Filtered Power** - Filtered +5V, +12V, and -12V DC power is provided to the IP modules via passive filters present on each supply line serving each IP. This provides optimum filtering and isolation between the IP modules and the carrier board and allows analog signals to be accurately measured or reproduced on IP modules without signal degradation from the carrier board logic signals.

VMEbus INTERFACE FEATURES

- **Slave Module-**
Carrier Register Short I/O Access A16, D16/D08(O)
IP Module ID Space A16, D16/D08(O)
IP Module I/O Space A16, D16/D08(E0)
IP Module Memory Space A24, D16/D08(E0)
- **Supports Short I/O Address Modifiers** - Supports short I/O (A16) address modifiers 29H, 2DH (H = Hex). Short I/O space is used for all carrier registers and IP module I/O and ID spaces. The carrier board base address is set by hardware jumpers and decoded on 1K byte boundaries.
- **Supports Standard I/O Address Modifiers** - Supports standard (A24) address modifiers 39H, 3DH (H = Hex). Standard address space is used when an IP supports memory space. The carrier board is configured using programmable registers to set the IP starting address and size (1Mbyte to 8Mbytes).
- **Supports Read-Modify-Write Cycles** - Carrier board supports VMEbus read-modify-write cycles.

- **Interrupt Support** - I(1-7) interrupter D16/D08 (O). Up to two interrupt requests are supported for each IP module. The VMEbus interrupt level is software programmable. Carrier board software programmable registers are utilized as interrupt request control and status monitors. Interrupt release mechanism is Release On Register Access (RORA) type.

SIGNAL INTERFACE PRODUCTS

(See Appendix for more information on compatible products)

This IP carrier board will mate directly to all industry standard IP modules. Acromag provides the following interface products (all connections to field signals are made through the carrier board which passes them to the individual IP modules):

Cables:

Model 5025-551-X (Shielded Cable) or Model 5025-550-X (Non-Shielded Cable): A Flat 50-pin cable with female connectors at both ends for connecting AVME9630/9660, or other compatible carrier boards, to Model 5025-552 termination panels. The unshielded cable is recommended for digital I/O, while the shielded cable is recommended for optimum performance with precision analog I/O applications.

Termination Panel:

Model 5025-552: DIN-rail mountable panel provides 50 screw terminals for universal field I/O termination. Connects to Acromag AVME9630/9660, or other compatible carrier boards, via flat 50-pin ribbon cable (Model 5025-550-X or 5025-551-X).

Transition Module:

Model TRANS-GP: This module repeats field I/O connections of IP modules A through D for rear exit from the card cage. It is available for use in card cages which provide rear exit for I/O connections via transition modules (transition modules can only be used in card cages specifically designed for them). It is a double-height (6U), single-slot module with front panel hardware adhering to the VMEbus mechanical dimensions, except for shorter printed circuit board depth. Connects to Acromag Termination Panel 5025-552 from the rear of the card cage, and to AVME9630/ 9660 boards within the card cage, via flat 50-pin ribbon cable within the card cage (cable Model 5025-550-X or 5025-551-X).

INDUSTRIAL I/O PACK SOFTWARE LIBRARY

Acromag provides an Industrial I/O Pack Software Library diskette (Model IPSW-LIB-M03-1.44MB, MSDOS format) to simplify communication with Acromag IP modules. All functions are written in the "C" programming language and can be linked to your application. Refer to the "README.TXT" file in the root directory on the diskette for more details and the "96X0.TXT" files of the "AVME9660/9630" subdirectories that correspond to your carrier model.

2.0 PREPARATION FOR USE

UNPACKING AND INSPECTION

Upon receipt of this product, inspect the shipping carton for evidence of mishandling during transit. If the shipping carton is badly damaged or water stained, request that the carrier's agent be present when the carton is opened. If the carrier's agent is absent when the carton is opened and the contents of the carton are damaged, keep the carton and packing material for the agent's inspection.

For repairs to a product damaged in shipment, refer to the Acromag Service Policy to obtain return instructions. It is suggested that salvageable shipping cartons and packing material be saved for future use in the event the product must be shipped.

This board is physically protected with packing material and electrically protected with an anti static bag during shipment. It is recommended that the board be visually inspected for evidence of mishandling prior to applying power.

The board utilizes static sensitive components and should only be handled at a static-safe workstation.

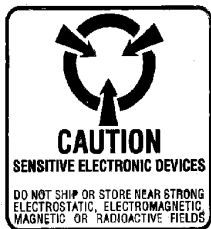

CARD CAGE CONSIDERATIONS

Refer to the specifications for loading and power requirements. Be sure that the system power supplies are able to accommodate the power requirements of the carrier board, plus the installed IP modules, within the voltage tolerances specified.

IMPORTANT: Adequate air circulation must be provided to prevent a temperature rise above the maximum operating temperature.

The dense packing of the IP modules to the carrier board restricts air flow within the card cage and is cause for concern. Adequate air circulation must be provided to prevent a temperature rise above the maximum operating temperature and to prolong the life of the electronics. If the installation is in an industrial environment and the board is exposed to environmental air, careful consideration should be given to air-filtering.

BOARD CONFIGURATION

The carrier board may be configured for different applications. All possible configuration settings will be discussed in the following Sections. The jumper locations and IP module positions are shown in Drawing 4501-450. Power should be removed from the board when installing IP modules, cables, termination panels, and field wiring. Refer to Mechanical Assembly Drawing 4501-434 and your IP module documentation for specific configuration and assembly instructions.

VMEbus INTERFACE CONFIGURATION

The carrier board is shipped from the factory configured as follows:

- Carrier board with VMEbus Short I/O Base Address of 0000H. Board will respond to both Address Modifiers 29H and 2DH. Registers on the carrier board plus the I/O and ID spaces on any installed IP modules will be accessible.
- Programmable software registers default to IP memory space (VMEbus standard address space) accesses disabled.
- Programmable software registers default to IP interrupt requests-disabled and VMEbus interrupt level-none.

Address Decode Jumper Configuration

The carrier board interfaces with the VMEbus as a 1K byte block of address locations in the VMEbus short I/O address space (refer to Section 3 for memory map details). J1 decodes the six most significant address lines A10 through A15 to provide segments of 1K address space. The configuration of the jumpers for different base address locations is shown in Table 2.1. "IN" means that the pins are shorted together with a shorting clip. "OUT" indicates that the clip has been removed.

Table 2.1: Address Decode Jumper Selections (J1 Pins)

Base Addr* (Hex)	A15 (11&12)	A14 (9&10)	A13 (7&8)	A12 (5&6)	A11 (3&4)	A10 (1&2)
0000	OUT	OUT	OUT	OUT	OUT	OUT
0400	OUT	OUT	OUT	OUT	OUT	IN
0800	OUT	OUT	OUT	OUT	IN	OUT
0C00	OUT	OUT	OUT	OUT	IN	IN
1000	OUT	OUT	OUT	IN	OUT	OUT
.
.
.
EC00	IN	IN	IN	OUT	IN	IN
F000	IN	IN	IN	IN	OUT	OUT
F400	IN	IN	IN	IN	OUT	IN
F800	IN	IN	IN	IN	IN	OUT
FC00	IN	IN	IN	IN	IN	IN

* Consult your host CPU manual for detailed information about addressing the VMEbus short I/O (A16, 16-bit) space. In many cases, CPU's utilizing 24-bit addressing will start the 16-bit address at FF0000 (Hex), and 32-bit CPU's at FFFF0000 (Hex).

VMEbus Address Modifiers

No hardware jumper configuration is needed. The carrier board will respond to both address modifiers 29H and 2DH in the VMEbus short I/O space. This means that both short supervisory and short non-privileged accesses are supported.

The carrier board will respond to both address modifiers 39H and 3DH in the VMEbus standard address space, when standard address space accesses to IP memory are enabled via programmable registers on the carrier board (refer to Section 3 for programming details).

Interrupt Configuration

No hardware jumper configuration is required. All interrupt enabling, status, and VMEbus interrupt level selections are configured via programmable registers on the carrier board (see Section 3 for programming details). The carrier board passes interrupt requests from the IP modules to the VMEbus--It does not originate interrupt requests. Refer to the IP modules for their specific configuration requirements.

CONNECTORS

Carrier Field I/O Connectors (IP modules A through D)

Field I/O connections are made via front panel connectors A, B, C, and D for IP modules in positions A through D, respectively (C & D not used on AVME9630). IP module assignment is marked on the front panel for easy identification (see jumper & IP location drawing 4501-450 for physical locations of the IP modules). Flat cable assemblies and Acromag termination panels (or user defined terminations) can be quickly mated to the front panel connectors. Pin assignments are defined by the IP module employed since the pins from the IP module field side correspond identically to the pin numbers of the front panel connectors.

Connectors A through D are 50-pin header (male) connectors (3M 3433-D303). Connectors are high-density, stacked ("Condo") type with A & B and C & D residing on the same part. These connectors include long ejector latches and 30 microns of gold in the mating area for excellent connection integrity (per MIL-G-45204, Type II, Grade C).

IP Field I/O Connectors (IP modules A through D)

The field side connectors of IP modules A through D mate to connectors P7-P10, respectively, on the carrier board (P9 & P10 are not used on Model AVME9630). IP location is silk-screened on the board for easy identification. Field and logic side connectors are keyed to avoid incorrect assembly.

P7-P10 are 50-pin plug header (male) connectors. These AMP 173280-3 connectors mate to AMP 173279-3 connectors (or similar) on the IP modules. This provides excellent connection integrity and utilizes gold plating in the mating area. Threaded metric M2 screws and spacers (supplied with Acromag IP modules) provide additional stability for harsh environments (see Drawing 4501-434 for assembly details).

Pin assignments for these connectors are made by the specific IP model used and correspond identically to the pin numbers of the front panel connectors.

IP Logic Interface Connectors (IP modules A through D)

The logic interface sides of IP modules A through D mate to connectors P11-P14 (P13 & P14 are not used on Model AVME9630), respectively, on the carrier board. IP location is silk-screened on the board for easy identification. Field and logic side connectors are keyed to avoid incorrect assembly.

P11-P14 are 50-pin male plug header connectors. These AMP 173280-3 connectors mate to AMP 173279-3 connectors (or similar) on the IP modules. This provides excellent connection integrity and utilizes gold plating in the mating area. Threaded metric M2 screws and spacers (supplied with Acromag IP modules) provide additional stability for harsh environments (see Drawing 4501-434 for assembly details).

Pin assignments for these connectors are defined by the IP module specification and are shown in Table 2.2:

Table 2.2: Standard IP Logic Interface Connections (P11-P14)

Pin Description	Number	Pin Description	Number
GND	1	GND	26
CLK	2	+5V	27
Reset*	3	R/W*	28
D00	4	IDSEL*	29
D01	5	<i>DMAReq0*</i>	30
D02	6	MEMSEL*	31
D03	7	<i>DMAReq1*</i>	32
D04	8	IntSel*	33
D05	9	<i>DMAck0*</i>	34
D06	10	IOSEL*	35
D07	11	<i>RESERVED</i>	36
D08	12	A1	37
D09	13	<i>DMAEnd*</i>	38
D10	14	A2	39
D11	15	ERROR*	40
D12	16	A3	41
D13	17	INTReq0*	42
D14	18	A4	43
D15	19	INTReq1*	44
BS0*	20	A5	45
BS1*	21	<i>STROBE*</i>	46
-12V	22	A6	47
+12V	23	ACK*	48
+5V	24	<i>RESERVED</i>	49
GND	25	GND	50

Asterisk (*) is used to indicate an active-low signal.
BOLD ITALIC Logic Lines are NOT USED by the carrier board.

VMEbus Connections

Table 2.3 indicates the pin assignments for the VMEbus signals at the P1 connector. The P1 connector is the upper rear connector on the AVME9630/9660 board, as viewed from the front. The connector consists of 32 rows of three pins labeled A, B, and C. Pin A1 is located at the upper left hand corner of the connector if the board is viewed from the front. VMEbus connector P2 is not used.

Refer to the VMEbus specification for additional information on the VMEbus signals.

TABLE 2.3: VMEbus P1 CONNECTIONS

Pin	Description	Pin	Description	Pin	Description
1A	D00	1B	BBSY*	1C	D08
2A	D01	2B	BCLR*	2C	D09
3A	D02	3B	ACFAIL*	3C	D10
4A	D03	4B	BG0IN*	4C	D11
5A	D04	5B	BG0OUT*	5C	D12
6A	D05	6B	BG1IN*	6C	D13
7A	D06	7B	BG1OUT*	7C	D14
8A	D07	8B	BG2IN*	8C	D15
9A	GND	9B	BG2OUT*	9C	GND
10A	SYSCLK	10B	BG3IN*	10C	SYSFAIL*
11A	GND	11B	BG3OUT*	11C	BERR*
12A	DS1*	12B	BR0*	12C	SYSRESET*
13A	DS0*	13B	BR1*	13C	LWORD*
14A	WRITE*	14B	BR2*	14C	AM5
15A	GND	15B	BR3*	15C	A23
16A	DTACK*	16B	AM0	16C	A22
17A	GND	17B	AM1	17C	A21
18A	AS*	18B	AM2	18C	A20
19A	GND	19B	AM3	19C	A19
20A	IACK*	20B	GND	20C	A18
21A	IACKIN*	21B	SERCLK	21C	A17
22A	IACKOUT*	22B	SERDAT*	22C	A16
23A	AM4	23B	GND	23C	A15
24A	A07	24B	IRQ7*	24C	A14
25A	A06	25B	IRQ6*	25C	A13
26A	A05	26B	IRQ5*	26C	A12
27A	A04	27B	IRQ4*	27C	A11
28A	A03	28B	IRQ3*	28C	A10
29A	A02	29B	IRQ2*	29C	A09
30A	A01	30B	IRQ1*	30C	A08
31A	-12V	31B	+5V STDBY	31C	+12V
32A	+5V	32B	+5V	32C	+5V

Asterisk (*) is used to indicate an active-low signal.
BOLD ITALIC Logic Lines are NOT USED by the carrier board.

POWER-UP TIMING AND LOADING

The AVME9630/9660 boards use a Field Programmable Gate-Array (FPGA) to handle the bus interface and control logic timing. Upon power-up, the FPGA automatically clocks in configuration vectors from a local PROM to initialize the logic circuitry for normal operation. This time is measured as the first 145mS (typical) after the +5 Volt supply rises to +2.5 Volts at power-up. The VMEbus specification requires that the bus master drive the system reset for the first 200mS after power-up, thus inhibiting any data transfers from taking place.

IP control registers are also reset following a power-up sequence, disabling interrupts, etc. (see Section 3 for details).

DATA TRANSFER TIMING

VMEbus data transfer time is measured from the falling edge of DSx* to the falling edge of DTACK* during a normal data transfer cycle. Typical transfer times are given in the following table.

Register	Data Transfer Time
All Carrier Registers	500 nS, Typical.
IP Registers	750 nS, Typical, If No Wait States*

* See IP module specifications for information on wait states. IP module register access time will increase by the number of wait states multiplied by 125nS (the period of the 8 MHz clock).

FIELD GROUNDING CONSIDERATIONS

Carrier boards are designed with passive filters on each supply line to each IP module. This provides maximum filtering and signal isolation between the IP modules and the carrier board. However, the boards are considered non-isolated, since there is electrical continuity between the VMEbus and the IP grounds. Therefore, unless isolation is provided on the IP module itself, the field I/O connections are not isolated from the VMEbus. Care should be taken in designing installations without isolation to avoid ground loops and noise pickup. This is particularly important for analog I/O applications when a high level of accuracy/resolution is needed (12-bits or more). Contact your Acromag representative for information on our many isolated signal conditioning products that could be used to interface to the IP input/output modules.

3.0 PROGRAMMING INFORMATION

This Section provides the specific information necessary to operate the AVME9630/9660 non-intelligent carrier boards.

The board is addressable on 1K byte boundaries in the Short I/O (A16) Address Space. This Acromag VMEbus non-intelligent slave (carrier board) has a Board Status register, but no ID PROM. ID PROM's are provided per the Industrial I/O Pack logic interface specification on the mezzanine (IP) boards which are installed on the carrier. The 1K byte of memory consumed by the board is composed of blocks of memory for the I/O and ID spaces of up to four IP modules. The rest of the 1K byte address space is unused, or contains registers or memory specific to the function of the carrier board. The memory map for AVME9630 and AVME9660 are shown in Tables 3.1A and 3.1B respectively. Note that the memory maps for the two models are identical for IP modules A and B and the control register locations. The AVME9630 does not contain IP modules C or D.

MEMORY MAPS

Table 3.1A: AVME9630 3U Carrier Bd Short I/O Memory Map

Base Address + (Hex)	EVEN Byte		ODD Byte		Base Address + (Hex)
	D15	D08	D07	D00	
0000 ↓ 007E	IP A I/O Space High Byte		IP A I/O Space Low Byte		0001 ↓ 007F
0080 ↓ 00BE	Not Used		IP A ID Space Low Byte		0081 ↓ 00BF
00C0 ↓ 00FE	Not Used		Carrier Board Registers (See Table 3.1C)		00C1 ↓ 00FF
0100 ↓ 017E	IP B I/O Space High Byte		IP B I/O Space Low Byte		0101 ↓ 017F
0180 ↓ 01BE	Not Used		IP B ID Space Low Byte		0181 ↓ 01BF
01C0 ↓ 01FE	Not Used		Not Used		01C1 ↓ 01FF
0200 ↓ 03FE	Not Used		Not Used		0201 ↓ 03FF

Table 3.1B: AVME9660 6U Carrier Bd Short I/O Memory Map

Base Address + (Hex)	EVEN Byte		ODD Byte		Base Address + (Hex)
	D15	D08	D07	D00	
0000 ↓ 007E	IP A I/O Space High Byte		IP A I/O Space Low Byte		0001 ↓ 007F
0080 ↓ 00BE	Not Used		IP A ID Space Low Byte		0081 ↓ 00BF
00C0 ↓ 00FE	Not Used		Carrier Board Registers (See Table 3.1C)		00C1 ↓ 00FF
0100 ↓ 017E	IP B I/O Space High Byte		IP B I/O Space Low Byte		0101 ↓ 017F
0180 ↓ 01BE	Not Used		IP B ID Space Low Byte		0181 ↓ 01BF
01C0 ↓ 01FE	Not Used		Not Used		01C1 ↓ 01FF
0200 ↓ 027E	IP C I/O Space High Byte		IP C I/O Space Low Byte		0201 ↓ 027F
0280 ↓ 02BE	Not Used		IP C ID Space Low Byte		0281 ↓ 02BF
02C0 ↓ 02FE	Not Used		Not Used		02C1 ↓ 02FF
0300 ↓ 037E	IP D I/O Space High Byte		IP D I/O Space Low Byte		0301 ↓ 037F
0380 ↓ 03BE	Not Used		IP D ID Space Low Byte		0381 ↓ 03BF
03C0 ↓ 03FE	Not Used		Not Used		03C1 ↓ 03FF

The Input/Output (IO) and Identification (ID) spaces of each IP are accessible via the VMEbus Short I/O space as shown in Tables 3.1A and 3.1B. The carrier board may optionally occupy memory in the VMEbus standard (A24) address space, if needed for IP modules containing Memory space. IP memory will only be mapped into the standard memory space if it is enabled for a particular IP per the user programmable IP Memory Enable Register (see Table 3.1C and subsequent description). The starting memory address for each enabled IP and the memory size for each enabled IP module is user-programmable via its associated IP Memory Base Address & Size Register (see Table 3.1C and subsequent description).

Table 3.1C: AVME9630/9660 Carrier Board Registers

Base Address + (Hex)	EVEN Byte		ODD Byte		Base Address + (Hex)
	D15	D08	D07	D00	
00C0	Not Used		Carrier Board Status Register		00C1
00C2	Not Used		Interrupt Level Register		00C3
00C4	Not Used		IP Error Register		00C5
00C6	Not Used		IP Memory Enable Register		00C7
00C8 ↓ 00CE	Not Used		Not Used		00C9 ↓ 00CF
00D0	Not Used		IP_A Memory Base Address & Size Register		00D1
00D2	Not Used		IP_B Memory Base Address & Size Register		00D3
00D4	Not Used		IP_C Memory Base Address & Size Register*		00D5
00D6	Not Used		IP_D Memory Base Address & Size Register*		00D7
00D8 ↓ 00DE	Not Used		Not Used		00D9 ↓ 00DF
00E0	Not Used		IP Interrupt Enable Register		00E1
00E2	Not Used		IP Interrupt Pending Register		00E3
00E4	Not Used		IP Interrupt Clear Register		00E5
00E6 ↓ 00FE	Not Used		Not Used		00E7 ↓ 00FF

* Registers not used on AVME9630.

Identification PROM - (Read Only, 32 Odd-Byte Addresses)

Each IP contains an identification (ID) PROM that resides in the ID space per the IP specification. This area of memory contains 32 bytes of information at most. Both fixed and variable information may be present within the ID PROM. Fixed information includes the "IPAC" identifier, model number, and manufacturer's identification codes. Variable information may include unique information required for the module. The identification Section for each IP module is located in the carrier board memory map per Table 3.1. ID PROM bytes are addressed using only the odd addresses in a 64-byte block. The ID PROM contents are shown in Table 3.2 for a generic IP. Refer to the documentation of your IP module for specific information.

Table 3.2: Generic IP Module ID Space Identification (ID) PROM

Hex Offset From ID PROM Base Address	ASCII Character Equivalent	Numeric Value (Hex)	Field Description
01	I	49	All IP modules have 'IPAC'
03	P	50	
05	A	41	
07	C	43	
09		A3	Acromag ID Code
0B		mm	IP Model Code ¹
0D		00	Not Used (Revision)
0F		00	Reserved
11		00	Not Used (Driver ID Low Byte)
13		00	Not Used (Driver ID High Byte)
15		nn	Total Number of ID PROM Bytes
17		cc	CRC
19 to (2*nn - 1)		xx	IP Specific Space
(2*nn + 1) to 3F		yy	Not Used

Notes (Table 3.2):

- The IP model number is represented by a two-digit code within the ID PROM (e.g. the IP405 model is represented by 01 Hex).

Carrier Board Status Register - (Read/Write, Base + C1H)

The Carrier Board Status Register reflects and controls functions globally on the carrier board.

MSB D7	D6	D5	D4	D3	D2	D1	LSB D0
ACE ¹	Not Used	Not Used	Soft Reset	GIE ²	GIP ³	Not Used	Not Used

Notes:

- ACE – this bit is Auto Clear Interrupt Enable.
- GIE – this bit is a Global Interrupt Enable.
- GIP – this bit is Global Interrupt Pending.

Where:

- Bits 7
Writing a "1" to this bit will enable automatic clear of pending interrupts on the carrier. When this bit is set pending interrupts will not be latched or registered on the carrier. An interrupt will only remain set as pending on the carrier if its corresponding IP module has an active interrupt request.
- Bits 6, 5
Not used - equal "0" if read
- Bit 4
Software Reset (Write)
Writing a "1" to this bit causes a software reset. Writing "0" or reading the bit has no effect. When set the software reset bit will have a duration of 1us. Reset Condition: Set to "0".
- Bit 3
Global Interrupt Enable (GIE) (Read/Write)
Writing a "1" to this bit enables interrupts to be serviced, provided that interrupts are supported and configured. A "0" disables servicing interrupts. Reset Condition: Set to "0", interrupts disabled.
- Bit 2
Global Interrupt Pending (GIP) (Read)
This bit will be "1" when there is an interrupt pending. This bit will be "0" when there is no interrupt pending. Polling this bit will reflect the board's pending interrupt status, even if the Global Interrupt Enable bit is set to "0". Reset condition: Set to "0".
- Bits 1, 0
Not used - equal "0" if read

Interrupt Level Register - (Read/Write, Base + C3H)

The carrier board passes interrupt requests from the IP modules to the VMEbus. It does not originate interrupt requests. The Interrupt Level Register allows the user to control the mapping of IP interrupt requests to the desired VMEbus interrupt level. Note that the "Global Interrupt Enable" bit in the Carrier Board Status Register must be set for interrupts to be enabled from the carrier board. Also, the specific IP interrupt request must be enabled via its corresponding bit in the Interrupt Enable Register, described subsequently.

MSB D7	D6	D5	D4	D3	D2	D1	LSB D0
Not Used	Not Used	Not Used	Not Used	Not Used	IL2	IL1	IL0

Where:

- Bits 7,6,5,4,3
Not used - equal "0" if read
- Bits 2,1,0
IL2-IL0 (Read/Write)
These bits control the VMEbus interrupt request level associated with IP interrupt requests as illustrated in the next table. Reset Condition: Set to "0", no interrupt request.

VMEbus Interrupt Level	IL2	IL1	IL0
None	0	0	0
1	0	0	1
2	0	1	0
3	0	1	1
4	1	0	0
5	1	0	1
6	1	1	0
7	1	1	1

IP Error Register - (Read, Base + C5H)

The IP Error Register allows the user to monitor the Error signals of IP modules A through D. The Industrial I/O Pack specification states that the error signals indicate a non-recoverable error from the IP (such as a component failure or hard-wired configuration error). Refer to your IP specific documentation to see if the error signal is supported and what it indicates.

MSB D7	D6	D5	D4	D3	D2	D1	LSB D0
Not Used	Not Used	Not Used	Not Used	IP-D Error *	IP-C Error *	IP-B Error	IP-A Error

* Bits not used on AVME9630 - equal "0" if read.

Where:

- Bits 7, 6, 5, 4 Not used - equal "0" if read
- Bit 3 This bit will be a "1" when IP D asserts its IP-D Error (Read) Error signal. This bit will be "0" when there is no error.
Reset Condition: Bit will be "0" (no error) unless driven by IP.
- Bit 2 This bit will be a "1" when IP C asserts its IP-C Error (Read) Error signal. This bit will be "0" when there is no error.
Reset Condition: Bit will be "0" (no error) unless driven by IP.
- Bit 1 This bit will be a "1" when IP B asserts its IP-B Error (Read) Error signal. This bit will be "0" when there is no error.
Reset Condition: Bit will be "0" (no error) unless driven by IP.
- Bit 0 This bit will be a "1" when IP A asserts its IP-A Error (Read) Error signal. This bit will be "0" when there is no error.
Reset Condition: Bit will be "0" (no error) unless driven by IP.

IP Memory Enable Register - (Read/Write, Base + C7H)

The IP Memory Enable Register allows the user to program which IP modules will be accessible in the standard (A24) memory space. An enable bit is associated with each IP A through D. This register must be used in conjunction with the IP Memory Base Address & Size Registers to fully define the addressable memory space of the IP modules. Enabling IP memory has no effect on the I/O and ID spaces of the module.

MSB D7	D6	D5	D4	D3	D2	D1	LSB D0
Not Used	Not Used	Not Used	Not Used	IP-D Mem Ena*	IP-C Mem Ena*	IP-B Mem Ena	IP-A Mem Ena

* These Bits are Not Used on AVME9630.

Where:

- Bits 7, 6, 5, 4 Not used - equal "0" if read.
- Bit 3 Writing a "1" to this bit enables the memory IP-D Memory Enable (Read/Write) space for IP D. A zero disables memory space accesses.
Reset Condition: Set to "0", memory space accesses disabled for IP D.

- Bit 2 Writing a "1" to this bit enables the memory IP-C Memory Enable (Read/Write) space for IP C. A zero disables memory space accesses.
Reset Condition: Set to "0", memory space accesses disabled for IP C.
- Bit 1 Writing a "1" to this bit enables the memory IP-B Memory Enable (Read/Write) space for IP B. A zero disables memory space accesses.
Reset Condition: Set to "0", memory space accesses disabled for IP B.
- Bit 0 Writing a "1" to this bit enables the memory IP-A Memory Enable (Read/Write) space for IP A. A zero disables memory space accesses.
Reset Condition: Set to "0", memory space accesses disabled for IP A.

IP Memory Base Address & Size Registers - (Read/Write)

- IP_A (Base + D1H)**
- IP_B (Base + D3H)**
- IP_C (Base + D5H), Not used on AVME9630**
- IP_D (Base + D7H), Not used on AVME9630**

The IP Memory Base Address & Size Registers are user programmable to define the starting address of standard (A24) memory space and the size of that memory space corresponding to IP modules A through D. The memory size for each enabled IP module is user-programmable from 1MByte to 8MByte in multiples of two. Note that memory on IP modules can only be accessed if enabled within the IP Memory Enable Register, and that the memory bases for enabled IP modules must not be programmed to overlap with each other. The size selected by these registers should be matched to that required by the associated IP.

Base Address				Not Used		Memory Size		
MSB D7	D6	D5	D4	D3	D2	D1	LSB D0	
A23	A22	A21	A20	Not Used	Not Used	0	0	1M
A23	A22	A21	Not Used	Not Used	Not Used	0	1	2M
A23	A22	Not Used	Not Used	Not Used	Not Used	1	0	4M
A23	Not Used	Not Used	Not Used	Not Used	Not Used	1	1	8M

Where:

- Bit 7, 6, 5, 4 These bits define the memory base address. IP Memory Base Address (Read/Write) Read and write operations are implemented on all bits even if labeled unused. Thus, a read operation will return the last value written.
Reset Condition: Set to "0", memory base address 0.
- Bit 3, 2 Not used - equal "0" if read.
- Bit 1, 0 These bits define the memory size selected IP Memory Size (Read/Write) 1MB, 2MB, 4MB, or 8MB as shown in the previous table.
Reset Condition: Set to "0", 1MB memory size.

IP Interrupt Enable Register - (Read/Write, Base + E1H)

The IP Interrupt Enable Register is used to individually enable/disable IP interrupts. Each IP A through D may have up to two requests. Note that the "Global Interrupt Enable" bit in the Carrier Board Status Register must be set for interrupts to be enabled from the carrier board. The user must also configure the VMEbus interrupt level using the Interrupt Level Register. If multiple IP interrupt sources are enabled, they will be serviced in order from highest to lowest priority with bit 0 (IP A Int0) having the highest priority and bit 7 (IP D Int1) having the lowest priority.

MSB D7 Lowest Priority	D6	D5	D4	D3	D2	D1	LSB D0 Highest Priority
IP D Int1* Ena	IP D Int0* Ena	IP C Int1* Ena	IP C Int0* Ena	IP B Int1 Ena	IP B Int0 Ena	IP A Int1 Ena	IP A Int0 Ena

* Bits not used on AVME9630.

Where:

All Bits
IP Interrupt Enable (Read/Write)

Writing a "1" to a bit enables interrupts for the corresponding IP module and interrupt level. A zero disables the corresponding interrupt.
Reset Condition: Set to "0", IP interrupts disabled.

IP Interrupt Pending Register - (Read, Base + E3H)

The IP Interrupt Pending Register is used to individually identify pending IP interrupts. If multiple IP interrupts are pending, they will be serviced in order from highest to lowest priority with bit 0 (IP A Int0) having the highest priority and bit 7 (IP D Int1) having the lowest priority.

MSB D7 Low Prior.	D6	D5	D4	D3	D2	D1	LSB D0 High Prior.
IP D Int1* Pend	IP D Int0* Pend	IP C Int1* Pend	IP C Int0* Pend	IP B Int1 Pend	IP B Int0 Pend	IP A Int1 Pend	IP A Int0 Pend

* Bits not used on AVME9630.

Where:

All Bits
IP Interrupt Pending (Read)

A bit will be a "1" when the corresponding IP interrupt is pending. A bit will be a "0" when its corresponding interrupt is not pending. Polling this bit will reflect the IP modules pending interrupt status, even if the IP interrupt enable bit is set to "0".
Reset Condition: Set to "0".

IP Interrupt Clear Register - (Write, Base + E5H)

The IP Interrupt Clear Register is used to individually clear the IP interrupt Pending bits set in the IP Interrupt Pending register.

MSB D7	D6	D5	D4	D3	D2	D1	LSB D0
IP D Int1* Clear	IP D Int0* Clear	IP C Int1* Clear	IP C Int0* Clear	IP B Int1 Clear	IP B Int0 Clear	IP A Int1 Clear	IP A Int0 Clear

* Bits not used on AVME9630.

Where:

All Bits
IP Interrupt Clear (Write)

Writing a "1" to a bit causes the corresponding IP interrupt Pending bit to clear. Writing "0" or reading has no effect.
Reset Condition: Set to "0".

GENERAL PROGRAMMING CONSIDERATIONS

The carrier board register architecture makes the configuration fast and easy. The only set of configuration hardware jumpers is for the base address of the carrier board in the VMEbus short I/O space. Once the carrier board is mapped to the desired base address, communication with its registers and the I/O and ID spaces of the IP modules is straightforward. The carrier board is easily configured to communicate with IP memory space, if present, through two configuration registers. Interrupt configuration/control, if supported by IP modules, is also easily done through registers.

Board Diagnostics

The board is a non-intelligent slave and does not perform self diagnostics. It does, however, provide front panel LED's to indicate successful communication with each of the four IP modules, A through D (C & D are not used on AVME9630). These LED's are driven by the corresponding IP acknowledge signal which is lengthened by circuitry on the carrier board to make the access visible to the user. This means that frequent accesses to an IP will result in constant LED illumination. The LED's indicate I/O, memory, interrupt acknowledge, and ID PROM accesses. Note that the LED's will not illuminate during accesses of carrier board registers, or accesses to IP modules which are not physically present, or to unsupported memory space. The LEDs may temporarily illuminate upon initial power-up. Additional information about the error status of the IP modules can be obtained by reading the IP Error Register.

GENERATING INTERRUPTS

Interrupt requests do not originate from the carrier board, but rather, from the IP modules. Each IP may support 0, 1, or 2 interrupt requests. The carrier board processes the request from the IP and uses the Interrupt Level Register data to map the request to the desired VMEbus interrupt level (if locally enabled within the Interrupt Enable Register and globally enabled within the Carrier Board Status Register). The carrier board then waits for an interrupt acknowledge from the VMEbus host after asserting the appropriate VMEbus interrupt request.

When the carrier board recognizes an interrupt acknowledge cycle on the VMEbus, it checks for a match of the IP interrupt requests. If none is pending or the interrupt level does not match, it will pass the acknowledgment signal along, without consuming it. If there is a match, the carrier board will initiate an acknowledgment cycle with the requesting IP, which must supply the interrupt vector during the cycle. The VMEbus interrupt acknowledge signal is consumed by the carrier board during a valid cycle. Note that if multiple IP interrupt requests are pending, then the carrier board will prioritize the requests and handle them in order.

Interrupt Configuration Example

1. Clear the global interrupt enable bit in the Carrier Board Status Register by writing a "0" to bit 3.
2. Write interrupt vector to the location specified on the IP and perform any other IP specific configuration required - do for each supported IP interrupt request.
3. Write to the Interrupt Level Register to program the desired interrupt level per bits 2,1,0.
4. Write "1" to the IP Interrupt Clear Register corresponding to the desired IP interrupt request(s) being configured.
5. Write "1" to the IP Interrupt Enable Register bits corresponding to the IP interrupt request to be enabled.
6. Enable interrupts from the carrier board by writing a "1" to bit 3 (global interrupt enable bit) in the Carrier Board Status Register.

Sequence of Events For an Interrupt

1. The IP asserts an interrupt request to the carrier board (asserts IntReq0* or IntReq1*).
2. The AVME9630/9660 carrier board acts as an interrupter in making the VMEbus interrupt request (asserts IRQx*) corresponding to the IP interrupt request.
3. The VMEbus host (interrupt handler) asserts IACK* and the level of the interrupt it is seeking on A01-A03.
4. When the asserted VMEbus IACKIN* signal (daisy-chained) is passed to the AVME9630/9660, the carrier board will check if the level requested matches that specified by the host. If so, the carrier board will assert the IntSel* line to the appropriate IP together with (carrier board generated) address bit A1 to select which interrupt request is being processed (A1 low corresponds to IntReq0*; A1 high corresponds to IntReq1*).
5. The IP puts the appropriate interrupt vector on the local data bus (D00-D07 if an D08 (O) interrupter or D00-D15 if a D16 interrupter), and asserts Ack* to the carrier board. The carrier board passes this along to the VMEbus (D08 [O] or D16) and asserts DTACK*.
6. The host uses the vector to point at which interrupt handler to execute and begins its execution.
7. Example of Generic Interrupt Handler Actions:
 - A. Disable the interrupting IP by writing a "0" to the appropriate bit in the IP Interrupt Enable Register.
 - B. Take any IP specific action required to remove the interrupt request at its source.
 - C. Clear the interrupting IP by writing a "1" to the appropriate bit in the IP Interrupt Clear Register.

- D. Enable the interrupting IP by writing a "1" to the appropriate bit in the IP Interrupt Enable Register.
8. If the IP interrupt stimulus has been removed and no other IP modules have interrupts pending, the interrupt cycle is completed (i.e. the carrier board negates its interrupt request).
 - A. If the IP interrupt stimulus remains, a new interrupt request will immediately follow. If the stimulus cannot be removed, then the IP should be disabled or reconfigured.
 - B. If other IP modules have interrupts pending, then the interrupt request (IRQx*) will remain asserted. This will start a new interrupt cycle.

4.0 THEORY OF OPERATION

This section describes the basic functionality of the circuitry used on the carrier board. Refer to the Block Diagram shown in the Drawing 4501-451 as you review this material.

CARRIER BOARD OVERVIEW

The carrier board is a VMEbus slave board providing up to four industry standard IP module interfaces for the AVME9660 and two IP module interfaces for the AVME9630. The carrier board's VMEbus interface allows an intelligent single board computer (VMEbus Master) to control and communicate with electronic devices that are external to the VMEbus card cage. The external electronic hardware is linked to the carrier board via ribbon cable which mates with the IP field connections of the carrier board. The electronic link from the field I/O connections to the carrier board is made via the IP module selected for your specific application.

To facilitate easy connection of external devices to the IP field I/O pins of the carrier board, optional Termination Panels are available. A ribbon cable connects a 50 pin IP field I/O connector on the carrier board to the Termination Panel. At the Termination Panel field I/O signals are connected to a 50 position terminal block via screw clamps. The AVME9660 contains four IP modules and thus 200 I/O connections are provided on the A, B, C, and D connectors. The AVME9630 contains two IP modules and provides 100 I/O connections on the A and B connectors.

The VMEbus and IP module logic commons have a direct electrical connection (i.e., they are not electrically isolated). However, the field I/O connections can be isolated from the VMEbus if an IP module that provides this isolation (between the logic and field side) is utilized. A wide variety of IP modules are currently available (from Acromag and other vendors) that allow interface to many external devices for both digital and analog I/O applications.

VMEbus Interface

The carrier board's VMEbus interface is used to program and monitor and carrier board's registers for configuration and control of the board's documented modes of operation (see section 3). In addition, the VMEbus interface is also used to communicate with and control external devices that are connected to an IP module's field I/O signals (assuming an IP module is present on the carrier board).

The VMEbus interface is implemented in the logic of the carrier board's Field Programmable Gate-Array (FPGA). The FPGA implements VMEbus specification revision C.1 as an interrupting slave including the following data transfers types.

- A16, D16/D08(O) Carrier Register Short I/O Access
- A16, D16/D08(O) IP Module ID Space
- A16, D16/D08(E0) IP Module I/O Space
- A24, D16/D08(E0) IP Module Memory Space

The carrier board's VMEbus data transfer rates are typically:

- 500ns for accesses to the carrier board registers.
- 750ns for data transfers to the IP modules (assuming 0 wait states on IP).

The carrier board's FPGA monitors the base address jumper setting which is jumperable on 1K byte boundaries in the VMEbus Short I/O (A16) Address Space. When the selected base address matches the (A16) address provided by the VMEbus master, the FPGA controls and implements the required bus transfer allowing communication with the carrier board's registers or IP modules.

Carrier Board Registers

The carrier board registers (presented in section 3) are implemented in the logic of the carrier board's FPGA. An outline of the functions provided by the carrier board registers include:

- Software reset can be issued to reset the FPGA Logic and all IP modules present on the carrier board via the **Status Register**.
- Monitoring the error signal received from each IP module is possible via the **IP Error Register**.
- Configuration of VMEbus A24 standard address space for optional Memory Space on each IP module is possible. Memory Space access to the IP modules can be individually enabled via the **IP Memory Enable Register**. The base address and address range (size) is programmed via carrier registers **IP_A, IP_B, IP_C, and IP_D Memory Base Address & Size Registers**. The address size can be selected from 1M, 2M, 4M, or 8M bytes.
- Enabling of VMEbus interrupt requests from each IP module via the **IP Interrupt Enable Register** is possible. The desired VMEbus interrupt level desired can be set (via the **Interrupt Level Register**), and pending interrupts can be monitored and cleared via carrier registers **IP Interrupt Pending and IP Interrupt Clear Registers**.
- Lastly, pending interrupts can be globally monitored and released to the VMEbus via the **Status Register**.

IP Logic Interface

The IP logic interface is also implemented in the logic of the carrier board's FPGA. The carrier board implements revision 0.7.1 Industrial I/O Pack logic interface specification and includes four IP logic interfaces on an AVME9660 and two interfaces on an AVME9630 carrier. The VMEbus address and data lines are linked to the address and data of the IP logic interface. This link is implemented and controlled by the carrier board's FPGA.

The VMEbus to IP logic interface link allows a VMEbus master to:

- Access up to 32 ID Space bytes for IP module identification via D08(O) data transfers using VMEbus A16 short address space.
- Access up to 128 I/O Space bytes of IP data via D16/D08(EO) data transfers using VMEbus A16 short address space.
- Access up to 8Mbytes of IP data mapped to Memory Space via D16 or D08(EO) transfers using VMEbus A24 standard address space.
- Respond to two IP module interrupt requests per IP with software programmable VMEbus interrupt levels.

Carrier Board Clock Circuitry

The VMEbus 16MHz system clock is divided down by the FPGA to obtain the IP module 8MHz clock signals. Separate IP clocks are driven to each IP module. All clock lines include series damping resistors to reduce clock overshoot and undershoot, and

similar length PC board trace lengths are employed to minimize clock skew between the IP modules.

IP Read and Write Cycle Timing

An IP read or write cycle is carried out via a VMEbus A24 or A16 data transfer. The data transfer starts when the VMEbus Data Strobe 0 (DS0*) goes active and ends when the carrier board drives Data Transfer Acknowledge (DTACK*) active back to the VMEbus master. The carrier board typically has a 750ns IP module data transfer cycle time.

A typical IP module data transfer cycle is described here, starting with DS0* going active. DS0* is sampled on the rising edge of the system 16MHz clock edge after it goes active. All operations are then synchronized to the IP 8MHz clock as required by the IP module specification. Thus, typically three 8MHz clock cycles later, an IP select line goes active (IOSEL*, IDSEL*, MEMSEL*, or INTSEL*). With no IP wait states, an active IP Acknowledge (ACK*) signal is driven active by the IP on the next rising edge of the 8MHz clock. The carrier board samples ACK* one clock cycle later and then asserts DTACK* active ending the VMEbus data transfer. The carrier board releases the select line (IOSEL*, IDSEL*, MEMSEL*, or INTSEL*) on the first rising edge of the 8MHz clock cycle after DS0* goes inactive.

Timing Diagram

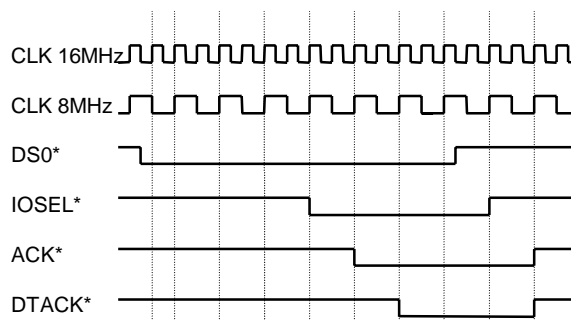

Note that the select line (IOSEL*, IDSEL*, MEMSEL* or INTSEL*) is held active a short time after DTACK* is issued. However, the IP module should not expect data to be held after ACK* is detected by the carrier board in a data write cycle.

If a select line (IOSEL*, IDSEL*, INTSEL*, or MEMSEL*) is driven active to an IP module and the IP module does not return ACK* active, then DTACK* will also not be generated by the carrier board. This will cause a bus transfer time-out error and the VMEbus system may need to be reset. In addition, the carrier board will remain in a state waiting for ACK* from the IP. To take it out of this state, a software reset can be issued.

When an IP module places data on the bus, for all data read cycles, any undriven data lines are read by the VMEbus as high because of pull-up resistors on the carrier board's data bus.

VME Interrupter

Interrupts are initiated from an interrupting IP module. However, the carrier board will only pass an interrupt generated by an IP module to the VMEbus if the carrier board has been first enabled for interrupts. Each IP module can initiate two interrupts which can be individually enabled on the carrier board. After interrupts are enabled on the carrier board via the Interrupt Enable Register (see section 3 for programming details), an IP generated interrupt is recognized by the carrier board and is recorded in the carrier board's Interrupt Pending Register.

A carrier board pending interrupt will cause the board to release the interrupt to the VMEbus provided the Global Interrupt Enable bit of the carrier's Status Register has been enabled (see section 3 for programming details).

The carrier board releases the interrupt to the VMEbus by asserting the interrupt request level as pre-programmed in the carrier's Interrupt Level Register. The carrier board's interrupt logic then monitors the VMEbus Interrupt Acknowledge Input (IACKIN*) signal.

An active IACKIN* signal, detected by the carrier board, is either passed to Interrupt Acknowledge Output (IACKOUT*) or consumed by the carrier board. IACKIN* is passed to IACKOUT* if the VMEbus interrupt level does not match that programmed into the carrier's Interrupt Level Register. If a match is detected, the carrier board responds to the interrupt by consuming IACKIN*.

The carrier board also responds to an interrupt by driving IP Interrupt Select (INTSEL*) active to the IP that generated the interrupt provided only one interrupt has been issued. If two or more interrupts occur at the same time, then INTSEL* is driven active to the IP with the highest priority (IP A int0 has the highest priority, IP D Int1 has the lowest priority, see section 3 for more detail). The IP module responds by placing the interrupt vector on the data bus and asserts ACK* active. The carrier then asserts DTACK* active, and the VMEbus master responds by executing the code at the address of the interrupt vector.

The user written interrupt routine should include code to clear the carrier board's pending interrupt via the carrier's Interrupt Clear Register (see section 3) since the interrupt release mechanism is type Release on Register Access (RORA). In addition, the IP module may need similar attention (see your IP module documentation).

Power Failure Monitor

The carrier board contains a 5 volts undervoltage monitoring circuit which provides a reset to the IP modules when the 5 volt power drops below 4.27 volts typical / 4.15 volts minimum. This circuitry is implemented per the Industrial I/O Pack specification.

Assess LEDs and Pulse Stretcher Circuitry

An LED display and pulse stretcher circuit is dedicated to each IP module for indication of a data transfer to/from the corresponding IP module. An IP acknowledged data transfer activates the pulse stretcher circuit. The pulse stretcher's circuit is programmed to illuminate the LED for a duration of 0.1 seconds typical.

Power Supply Filters

Power line filters are dedicated to each IP module for filtering of the +5, +12, and -12 volt supplies. The power line filters are a T type filter circuit comprising ferrite bead inductors and a feed-thru capacitor. The filters provide improved noise performance as is required on precision analog IP modules. Specifically, the filters are typically capable of over 40dB of insertion loss for undesirable noise and oscillations in the 100MHz frequency range and over 20dB of insertion loss for noise and oscillations in the 10MHz frequency range.

5.0 SERVICE AND REPAIR

SERVICE AND REPAIR ASSISTANCE

Surface-Mounted Technology (SMT) boards are generally difficult to repair. It is highly recommended that a non-functioning board be returned to Acromag for repair. The board can be damaged unless special SMT repair and service tools are used. Further, Acromag has automated test equipment that thoroughly checks the performance of each board. When a board is first produced and when any repair is made, it is tested, placed in a burn-in room at elevated temperature, and retested before shipment.

Please refer to Acromag's Service Policy Bulletin or contact Acromag for complete details on how to obtain parts and repair.

PRELIMINARY SERVICE PROCEDURE

Before beginning repair, be sure that all of the procedures in Section 2, Preparation For Use, have been followed. Also, refer to the documentation of your carrier board to verify that it is correctly configured. Replacement of the carrier and/or IP with one that is known to work correctly is a good technique to isolate a faulty board.

CAUTION: POWER MUST BE TURNED OFF BEFORE REMOVING OR INSERTING BOARDS

Acromag's Applications Engineers can provide further technical assistance if required. When needed, complete repair services are also available from Acromag.

6.0 SPECIFICATIONS

GENERAL SPECIFICATIONS

Operating Temperature.....	0 to +70°C
	-40 to +85°C (E Versions)
	Note that visual LED performance may be degraded below -20°C.
Relative Humidity.....	5-95% non-condensing
Storage Temperature.....	-55 to +100°C
Physical Configuration.....	AVME9630 (3U)
Length.....	3.937 inches (100.0 mm)
Width.....	6.299 inches (160.0 mm)
Board Thickness.....	0.062 inches (1.59 mm)
Max Component Height.....	0.550 inches (13.97 mm)
Recommended Card Spacing.....	0.800 inches, (20.32mm)
Physical Configuration.....	AVME9660 (6U)
Length.....	9.187 inches (233.3 mm)
Width.....	6.299 inches (160.0 mm)
Board Thickness.....	0.062 inches (1.59 mm)
Max Component Height.....	0.550 inches (13.97 mm)
Recommended Card Spacing.....	0.800 inches, (20.32mm)
Connectors:	
P1 (VMEbus).....	DIN 41612 96-pin Type C, Level II
P2 (VMEbus).....	Not Used.
A-D (Carrier Field I/O).....	50-pin Male Header x2 stacked "condo type" 3M 3433-D303 with ejector latches(AVME9660)
A, B (Carrier Field I/O):.....	50-pin Male Headers. No ejector latches(AVME9630)

- A: Right angle pins
3M 2550-5002UB (or equiv.)
- B: Straight pins,
3M 2550-6002UB (or equiv.)
- P7-P10 (IP Field I/O).....50-pin male plug header (AMP 173280-3 or equivalent).
P9,P10 are not present on AVME9630 (E).
- P11-P14 (IP Logic Interface)...50-pin male plug header (AMP 173280-3 or equivalent).
P13,P14 are not present on AVME9630 (E).

Power:

Board power requirements are a function of the installed IP modules. This specification lists currents for the carrier boards only. The carrier boards individually filter and provide +5V, +12V and -12V power to each IP from the VMEbus. Note that the VMEbus standard does not support +15V and -15V supplies, but the carrier boards are designed to handle these if needed for unique situations.

The power supply filters are typically capable of over 40dB of insertion loss for undesirable noise and oscillations in the 100MHz frequency range and over 20dB of insertion loss for noise and oscillations in the 10MHz frequency range.

The power failure monitor circuit provides a reset to IP modules when the 5 volt power drops below 4.27 volts typically / 4.15 volts minimum.

Currents specified are for the carrier board only, add the IP module currents for the total current required from each supply.

- +5 Volts (±5%).....AVME9630 (E) 210mA, Typical 275mA, Maximum.
AVME9660 (E) 210mA, Typical 275mA, Maximum.
- +12 Volts (±5%) or
+15 Volts (±5%).....0mA (Not Used)
- 12 Volts (±5%) or
-15 Volts (±5%).....0mA (Not Used)

Non-Isolated.....VMEbus and IP module logic commons have a direct electrical connection. As such, unless the IP module provides isolation between the logic and field side, the field I/O connections are not isolated from the VMEbus.

LED illuminate duration0.1 second, typical

VMEbus COMPLIANCE

- Specification.....This device meets or exceeds all written VME specifications per revision C.1 dated October 1985, IEC 821-1987 and IEEE 1014-1987.
- Data Transfer Bus.....A24/A16:D16/D08 (EO) DTB slave; supports Read-Modify-Write cycles.

VMEbus Access Time.....500nS Typical (all carrier board registers); measured from the falling edge of DSx* to the falling edge of DTACK*.
750nS Typical (IP registers with no wait states). See IP specifications for information on wait states. IP register access time will increase by the number of wait states multiplied by 125nS (the period of the 8 Mhz clock).

VMEbus Address Modifier Codes:

- Short I/O Space.....Base address is hardware jumper selectable. Occupies 1K byte. Responds to both address modifiers 29H & 2DH in the VMEbus short I/O space for carrier board registers and IP I/O and ID PROM spaces.
- Standard Address Space.....Responds to both address modifiers 39H & 3DH in the VMEbus standard address space when such accesses to IP memory are enabled via programmable registers on the carrier board. Base addresses and sizes of IP memory are programmable from 1M to 8M bytes.
- Interrupts.....Creates 1(1-7) programmable request levels (up to two requests sourced from each IP).
D16/D08(O) interrupter (interrupt vectors come from IP modules). Carrier registers for control & status monitoring. Interrupt release mechanism is Release On Register Access (RORA) type.

INDUSTRIAL I/O PACK COMPLIANCE

- Specification.....This device meets or exceeds all written Industrial I/O Pack specifications per revision 0.7.1.
- Electrical/Mechanical Interface....AVME9630 (E) supports two single-size IP modules (A-B), or one double-size. 32-bit IP modules are Not Supported.
AVME9660 (E) supports four single-size IP modules (A-D), or two double-size. 32-bit IP modules are Not Supported.
- I/O Space.....A16/D16 or D08(EO); supports 128 byte values per IP.
- ID Space.....A16/D08(O); supports 32 bytes per IP (consecutive odd-byte addresses). D16 is also supported with pull-ups on the carrier board holding the upper 8-bits high.
- Memory Space.....A24/D16 or D08(EO); supports 1M to 8M bytes per IP module.

Interrupts.....Supports two interrupt requests per
IP and interrupt acknowledge
cycles, D16/D08(O).

APPENDIX**CABLE: MODEL 5025-550-x (Non-Shielded)
MODEL 5025-551-x (Shielded)**

Type: Flat Ribbon Cable, 50-wires (female connectors at both ends). The '-x' suffix designates the length in feet (12 feet maximum). Choose shielded or unshielded cable according to model number. The unshielded cable is recommended for digital I/O, while the shielded cable is recommended for optimum performance with precision analog I/O applications.

Application: Used to connect Model 5025-552 termination panel to the AVME9630/9660 non-intelligent carrier board A-D connectors (Both have 50-pin connectors).

Length: Last field of part number designates length in feet (user-specified, 12 feet maximum). It is recommended that this length be kept to a minimum to reduce noise and power loss.

Cable: 50-wire flat ribbon cable, 28 gage. Non-Shielded cable model uses Acromag Part 2002-211 (3M Type C3365/50 or equivalent). Shielded cable model uses Acromag Part 2002-261 (3M Type 3476/50 or equivalent).

Headers (Both Ends): 50-pin female header with strain relief.

Header - Acromag Part 1004-512 (3M Type 3425-6600 or equivalent). *Strain Relief* - Acromag Part 1004-534 (3M Type 3448-3050 or equivalent).

Keying: Headers at both ends have polarizing key to prevent improper installation.

Schematic and Physical Attributes: For Non-Shielded cable model, see Drawing 4501-462. For Shielded cable model, see Drawing 4501-463.

Shipping Weight: 1.0 pound (0.5Kg), packed.

TERMINATION PANEL: MODEL 5025-552

Type: Termination Panel For AVME9630/9660 Boards

Application: To connect field I/O signals to the Industrial I/O Pack (IP). *Termination Panel*: Acromag Part 4001-040 (Phoenix Contact Type FLKM 50). The 5025-552 termination panel facilitates the connection of up to 50 field I/O signals and connects to the AVME9630/9660 3U/6U non-intelligent carrier boards (A-D connectors only) via a flat ribbon cable (Model 5025-550-x or 5025-551-x). The A-D connectors on the carrier board connect the field I/O signals to the P2 connector on each of the Industrial I/O Pack modules. Field signals are accessed via screw terminal strips. The terminal strip markings on the termination panel (1-50) correspond to P2 (pins 1-50) on the Industrial I/O Pack (IP). Each Industrial I/O Pack (IP) has its own unique P2 pin assignments. Refer to the IP module manual for correct wiring connections to the termination panel.

Schematic and Physical Attributes: See Drawing 4501-464.

Field Wiring: 50-position terminal blocks with screw clamps. Wire range 12 to 26 AWG.

Connections to AVME9630/9660: P1, 50-pin male header with strain relief ejectors. Use Acromag 5025-550-x or 5025-551-x cable to connect panel to VME board. Keep cable as short as possible to reduce noise and power loss.

Mounting: Termination panel is snapped on the DIN mounting rail.

Printed Circuit Board: Military grade FR-4 epoxy glass circuit board, 0.063 inches thick.

Operating Temperature: -40°C to +100°C.

Storage Temperature: -40°C to +100°C.

Shipping Weight: 1.25 pounds (0.6kg) packed.

TRANSITION MODULE: MODEL TRANS-GP

Type: Transition module for AVME9630/9660 boards.

Application: To repeat field I/O signals of IP modules A through D for rear exit from VME card cages. This module is available for use in card cages which provide rear exit for I/O connections via transition modules (transition modules can only be used in card cages specifically designed for them). It is a double-height (6U), single-slot module with front panel hardware adhering to the VMEbus mechanical dimensions, except for shorter printed circuit board depth. Connects to Acromag termination panel 5025-552 from the rear of the card cage, and to AVME9630/9660 boards within card cage, via flat 50-pin ribbon cable (cable Model 5025-550-X or 5025-551-X).

Schematic and Physical Attributes: See Drawing 4501-465.

Field Wiring: 100-pin header (male) connectors (3M 3433-D303 or equivalent) employing long ejector latches and 30 micron gold in the mating area (per MIL-G-45204, Type II, Grade C).

Connects to Acromag termination panel 5025-552 from the rear of the card cage via flat 50-pin ribbon cable (cable Model 5025-550-X or 5025-551-X).

Connections to AVME9630/9660: 50-pin header (male) connectors (3M 3433-1302 or equivalent) employing long ejector latches and 30 micron gold in the mating area (per MIL-G-45204, Type II, Grade C). Connects to AVME9630/9660 boards within the card cage via flat 50-pin ribbon cable (cable Model 5025-550-X or 5025-551-X).

Mounting: Transition module is inserted into a 6U-size, single-width slot at the rear of the VMEbus card cage.

Printed Circuit Board: Six-layer, military-grade FR-4 epoxy glass circuit board, 0.063 inches thick.

Operating Temperature: -40 to +85°C.

Storage Temperature: -55°C to +105°C.

Shipping Weight: 1.25 pounds (0.6Kg) packed.

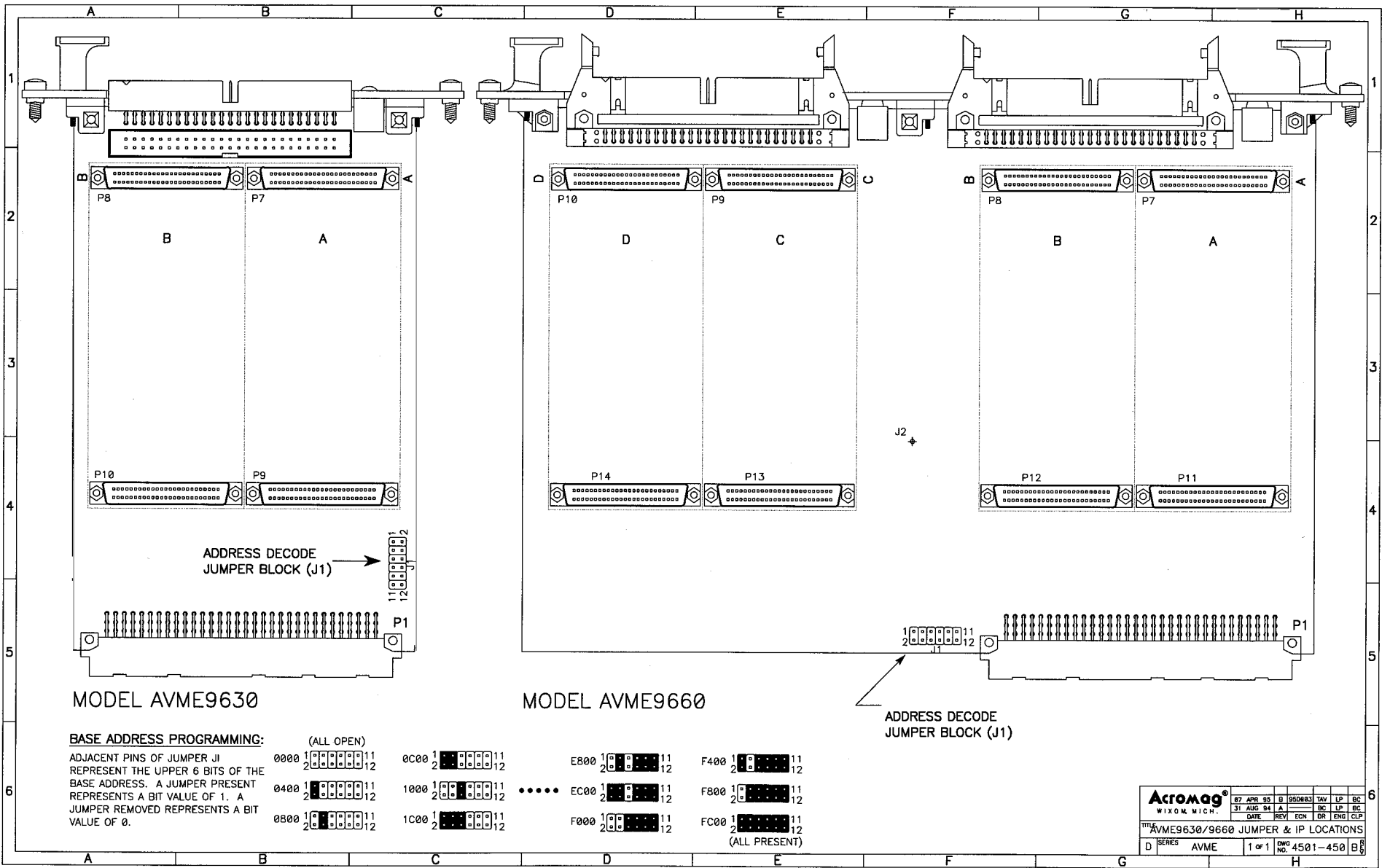

Acromag [®]		87	APR	88	B	950M63	RAW	LP	BC
WIXOM, MICH.		31	AUG	94	A		BC	LP	BC
		DATE	REV	ECN	DR	DR	ENG	CLP	
AVME9630/9660 JUMPER & IP LOCATIONS									
D	SERIES	AVME	1	of	1	DWG	No.	4501-450	B

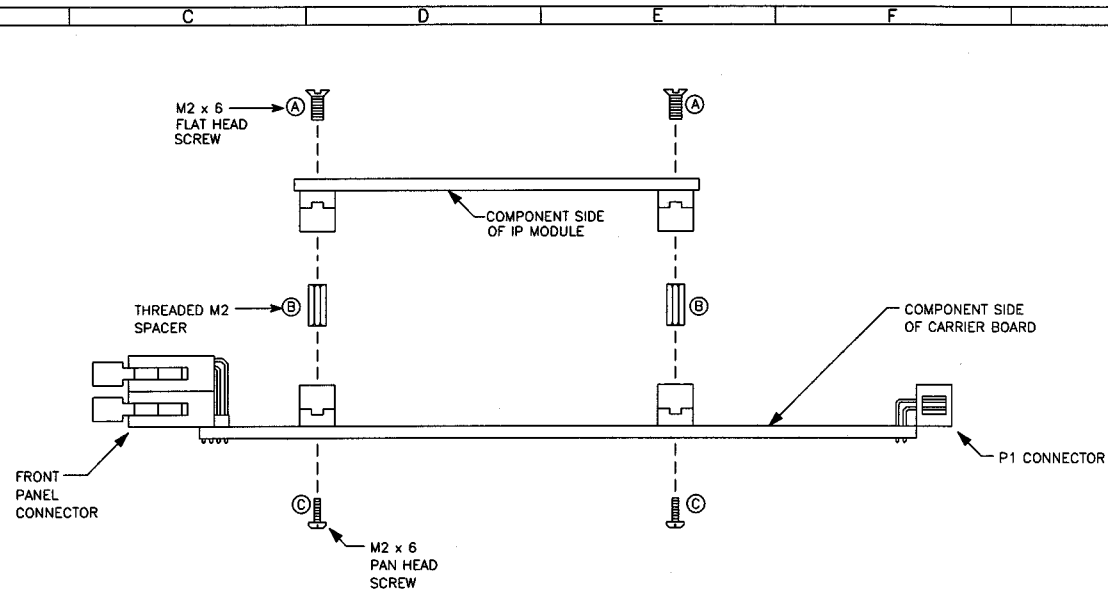

ASSEMBLY PROCEDURE:

1. THREADED SPACERS ARE PROVIDED IN TWO DIFFERENT LENGTHS. THE SHORTER LENGTH IS FOR USE WITH AVME 9630/9660 CARRIER BOARDS (SHOWN). CHECK YOUR CARRIER BOARD TO DETERMINE ITS REQUIREMENTS. MOUNTING HARDWARE PROVIDED MAY NOT BE COMPATIBLE WITH ALL TYPES OF CARRIER BOARDS.
2. INSERT FLAT HEAD SCREWS (ITEM A) THROUGH SOLDER SIDE OF IP MODULE AND INTO HEX SPACERS (ITEM B) AND TIGHTEN (4 PLACES) UNTIL HEX SPACER IS COMPLETELY SEATED.
3. CAREFULLY ALIGN IP MODULE TO CARRIER BOARD AND PRESS TOGETHER UNTIL CONNECTORS AND SPACERS ARE SEATED.
4. INSERT PAN HEAD SCREWS (ITEM C) THROUGH SOLDER SIDE OF CARRIER BOARD AND INTO HEX SPACERS (ITEM B) AND TIGHTEN (4 PLACES).

IP MODULE TO CARRIER BOARD MECHANICAL ASSEMBLY

Acromag WIXOM, MICH.		28-JUL-94	B	940811	TAV	JGV	BC
		21-DEC-93	A		TAV	JGV	BC
		DATE	REV	ECN	DR	ENG	CLP
TITLE IP MECHANICAL ASSEMBLY							
D	SERIES IP	1 OF 1	DWG NO. 4501-434		B		

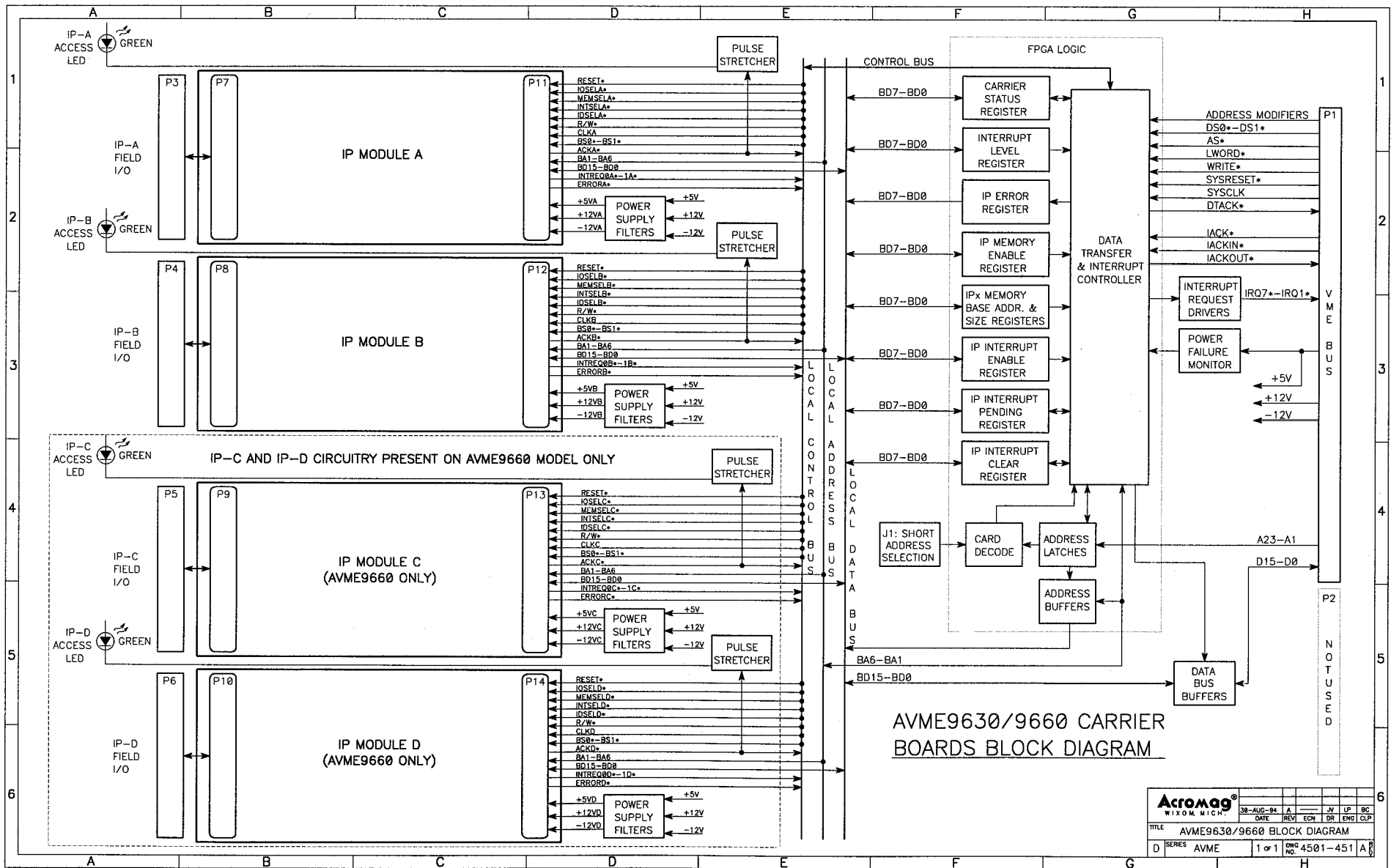

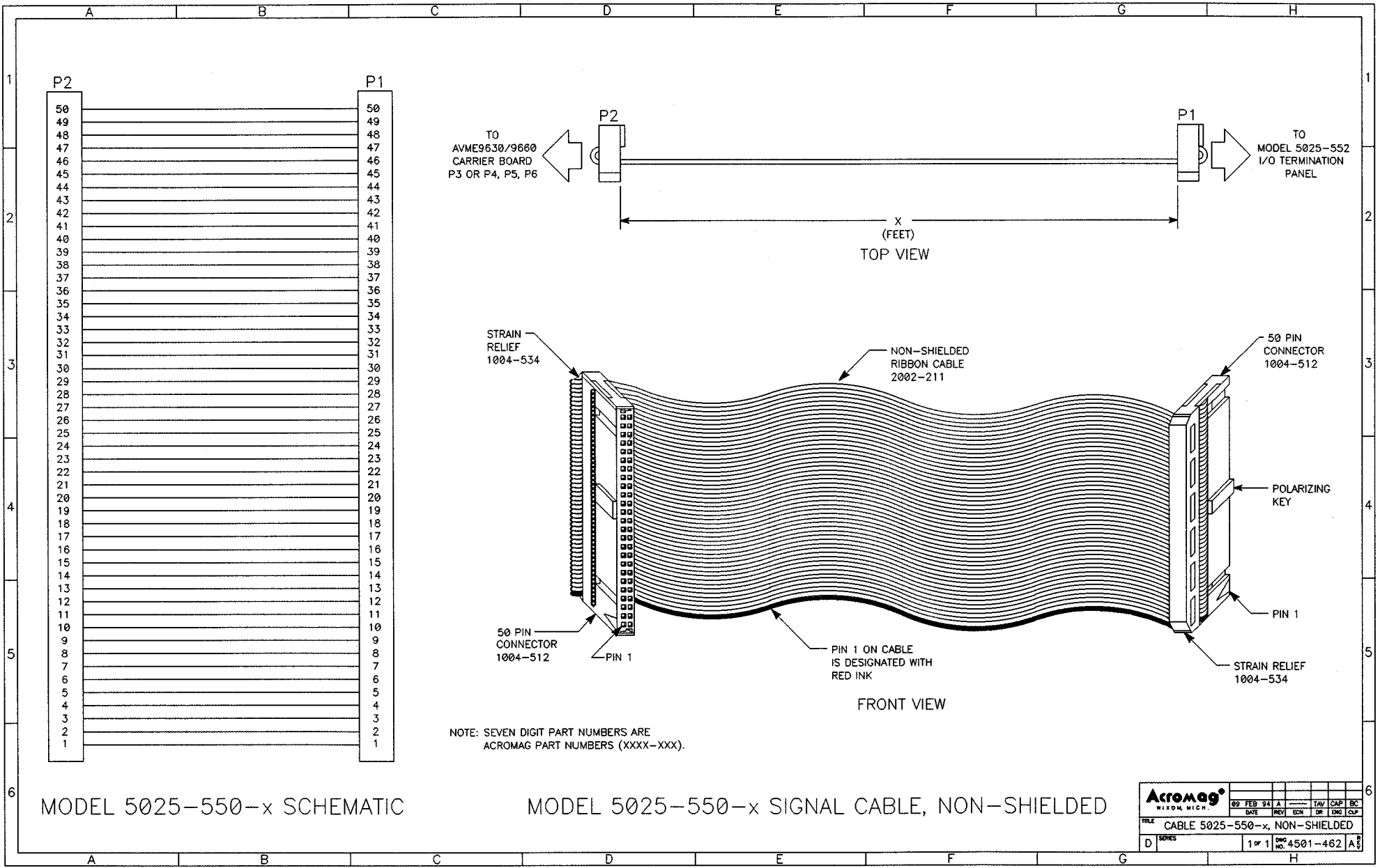

Acromag WILSON WICH.		09 FEB 94 A	REV	ECN	DR	TAV	CAP	BC
TITLE		CABLE 5025-550-x, NON-SHIELDED						
D	SERIES	1 of 1	DWG NO. 4501-462		A8			

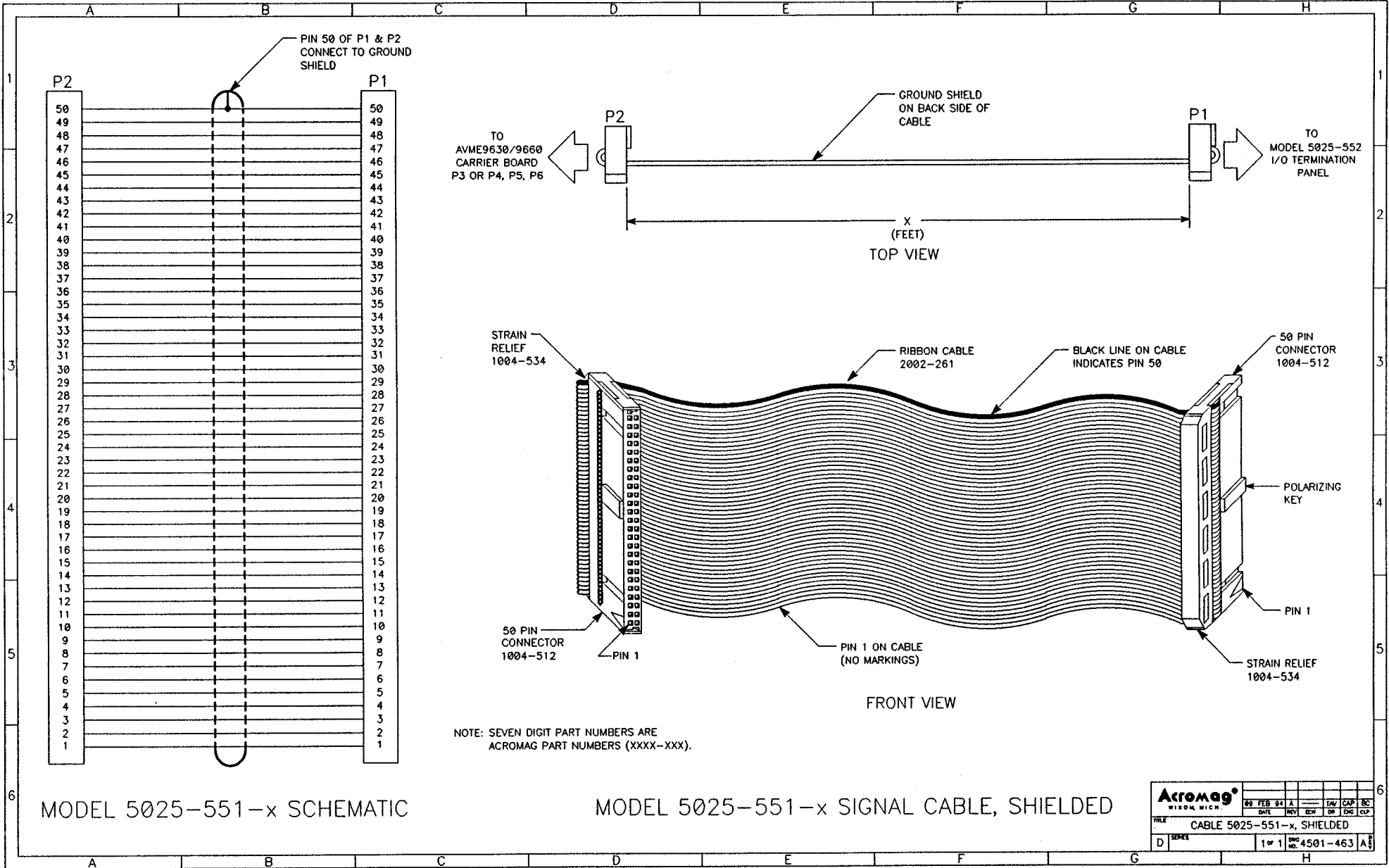

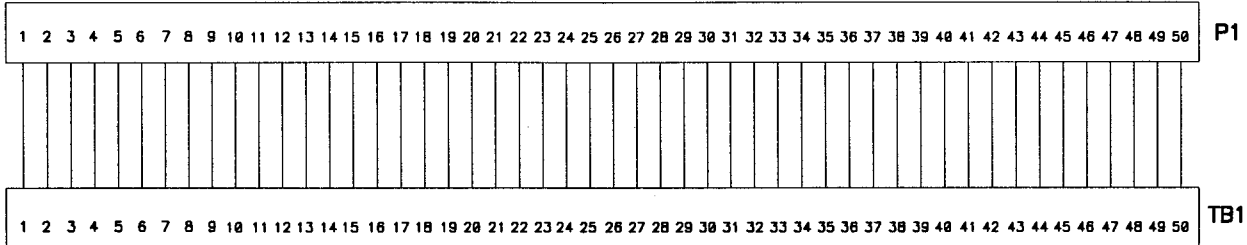

MODEL 5025-552 TERMINATION PANEL SCHEMATIC

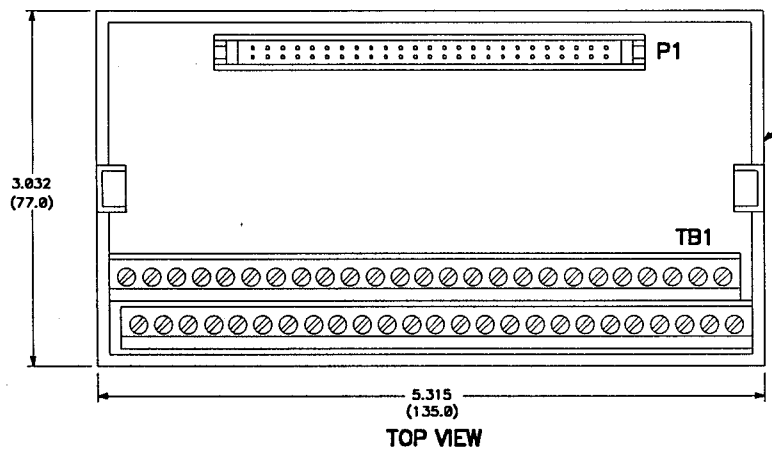

TOP VIEW

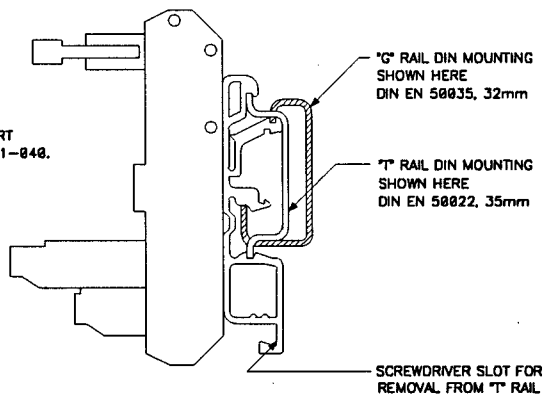

SIDE VIEW

TERMINATION
PANEL
ACROMAG PART
NUMBER 4001-040.

"G" RAIL DIN MOUNTING
SHOWN HERE
DIN EN 50035, 32mm

"T" RAIL DIN MOUNTING
SHOWN HERE
DIN EN 50022, 35mm

SCREWDRIVER SLOT FOR
REMOVAL FROM "T" RAIL

NOTES:
DIMENSIONS ARE IN INCHES (MILLIMETERS).
TOLERANCE: ± 0.020 (± 0.5).

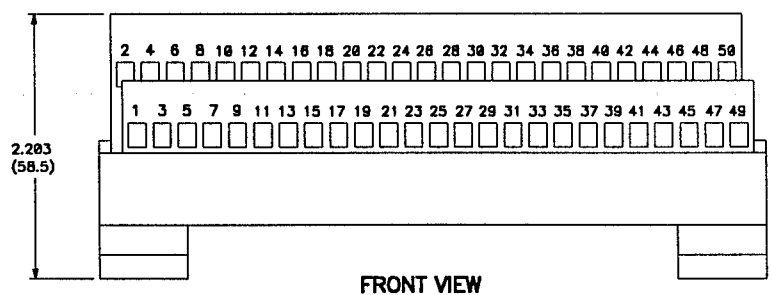

FRONT VIEW

MODEL 5025-552 TERMINATION PANEL

Acromag®						
WIXOM, MICH.		09 FEB 94	A	TAV	CAP	BC
		DATE	REV	ECN	DR	ENG
TITLE MODEL 5025-552 TERMINATION PANEL						
D	SERIES	1 of 1	DWG NO.	4501-464	A	REV

